

Features

- For use in bath/shower and shower only installations
- Designed for new installations or retrofit to replace an existing installed shower arm
- For use with temperature/volume control mixing valve (mixing valve sold separately)
- For use with Kohler handshowers and shower hoses

Material

- Premium metal construction for durability and reliability
- KOHLER finishes resist corrosion and tarnishing

Installation

- Wall-mount
- Installs in less than 60 minutes without changes to in-wall plumbing (subject to condition of existing installation)

Recommended Products/Accessories

K-23723 Faucet cleaner

Optional Products/Accessories

K-8593 72" Shower Hose
 K-9514 60" Shower Hose
 K-45981 72" ribbon hose
 K-45982 60" ribbon hose
 1194630 1/2" NPT Deep Rough-in Kit
 1187917 1/2" NPT Shallow Rough-in Kit
 1194302 Large Escutcheon/Mounting Collar Kit



ADA

Codes/Standards









ASME A112.18.1/CSA B125.1
 ADA
 IAPMO Certification

KOHLER® Faucet Lifetime Limited Warranty

See website for detailed warranty information.

Available Colors/Finishes

Color tiles intended for reference only.

Color	Code	Description
	CP	Polished Chrome
	SN	Vibrant® Polished Nickel
	AF	Vibrant® French Gold
	BN	Vibrant® Brushed Nickel
	BV	Vibrant® Brushed Bronze
	2BZ	Oil-Rubbed Bronze
	BL	Matte Black
	2MB	Vibrant® Brushed Moderne Brass
	TT	Vibrant Titanium

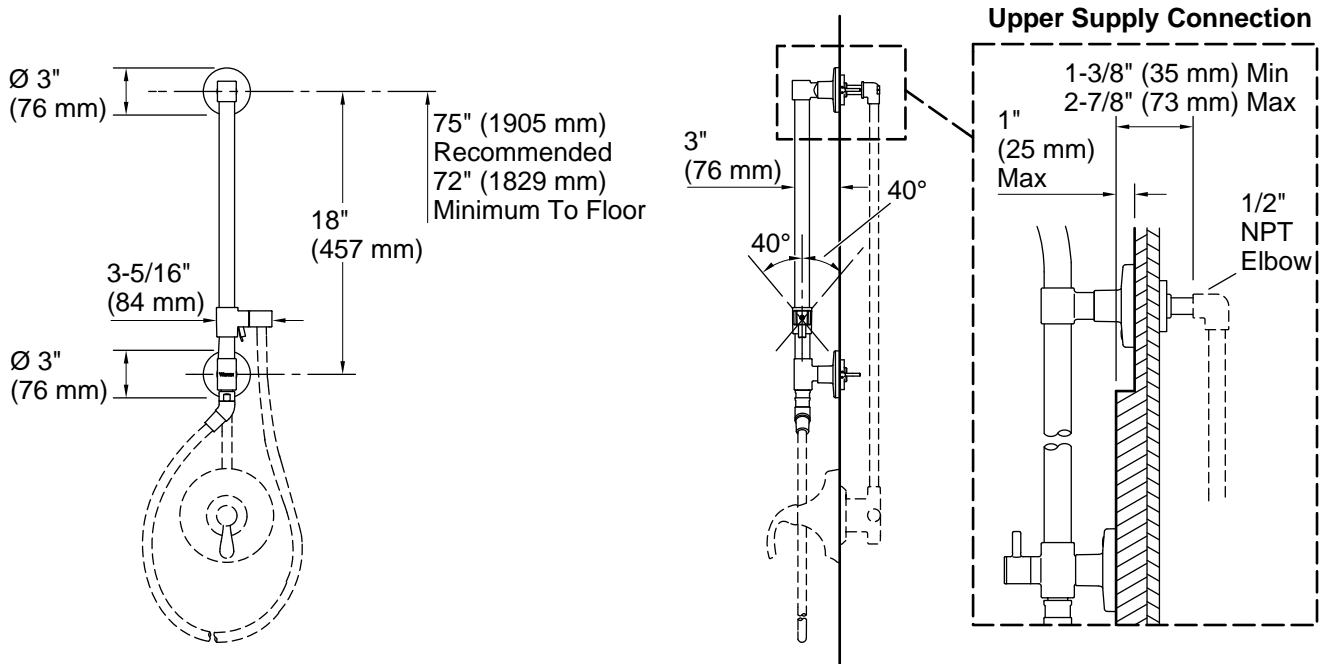

NOTE: Valve trim and hose illustrated for dimensioning only, not included in the product.

Technical Information

All product dimensions are nominal.

Drain included: No

Spout:

Handshower:

Rated maximum flow: 0 gal/min (0 l/min)

Notes

Install this product according to the installation guide.

Order deep roughing-in kit 1194630 if the distance from the elbow to the finished wall surface is between 2-7/8" (73 mm) to 4" (102 mm).

Order shallow roughing-in kit 1187917 if the distance from the elbow to the finished wall surface is less than 1-3/8" (35 mm).

A 3" (76 mm) escutcheon/mounting collar is supplied to fit a 1" (25 mm) to 1-1/4" (32 mm) supply connection hole diameter. Order 1194302 large escutcheon/mounting collar kit if the supply connection hole diameter is between 1-1/4" (32 mm) to 2-1/4" (57 mm).

ADA compliant when installed to the specific requirements of these regulations.