

Features

- Drilled for fixture-mount bidet faucet and vacuum breaker
- Front fill and vertical spray

Installation

- Above- or below-floor rough-in

Recommended Products/Accessories

K-23726 Drain treatment



Codes/Standards









ASME A112.19.2/CSA B45.1
IAPMO Certification

KOHLER® One-Year Limited Warranty

See website for detailed warranty information.

Available Colors/Finishes

Color tiles intended for reference only.

Color	Code	Description
	0	White
	96	Biscuit
	NY	Dune
	95	Ice™ Grey
	G9	Sandbar
	K4	Cashmere
	58	Thunder™ Grey
	7	Black Black™

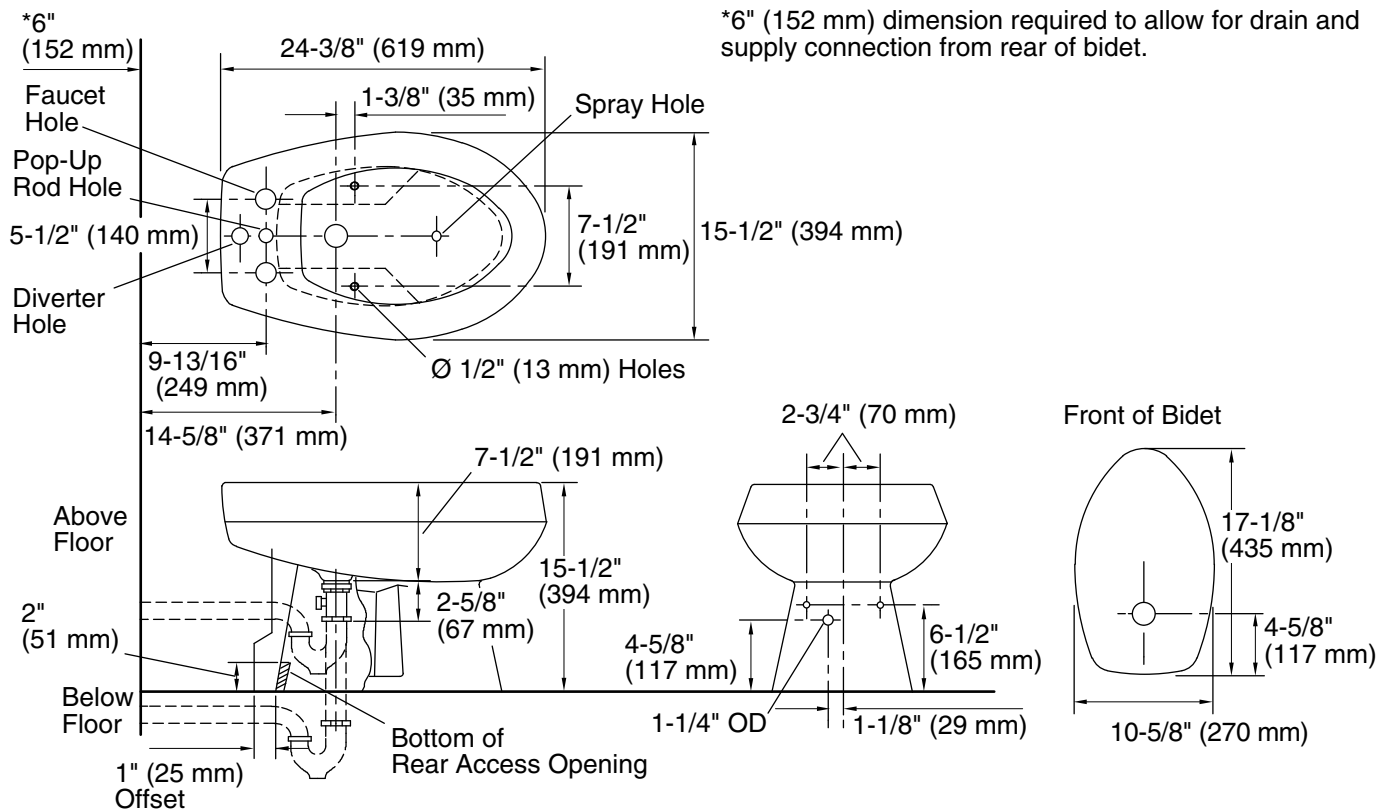

Technical Information

All product dimensions are nominal.

Notes

Install this product according to the installation instructions.

Hot and cold supplies can be installed from the floor or the wall.