



**Iron/Tones®**  
 Smart Divide® 33" top-/undermount double-bowl  
 kitchen sink  
**K-5312**

**Features**

- 33" (838 mm) minimum base cabinet width for top-mount installation
- 36" (914 mm) minimum base cabinet width for undermount installation
- Double-equal bowls
- 9" (229 mm) depth provides generous workspace
- Smart Divide® feature offers a lower bowl divider that increases workspace versatility



**Material**

- KOHLER® enameled cast iron

**Installation**

- Top-mount or undermount

**Recommended Products/Accessories**

- K-8801 Sink drain and strainer with tailpiece
- K-8799 Sink drain and strainer basket
- K-23726 Drain treatment
- K-23725 Cast iron cleaner
- 1411886 Undermount sink kit 23"

**Optional Products/Accessories**

- K-8339 Sink rack for Iron/Tones® Smart Divide® kitchen sink
- K-11352 Disposal Flange with Stopper
- K-9000 P-Trap

**Codes/Standards**











ASME A112.19.1/CSA B45.2  
 IAPMO Certification

**KOHLER® Enameled Cast Iron  
 Kitchen and Bathroom Sink Lifetime  
 Limited Warranty**

See website for detailed warranty information.

**Available Colors/Finishes**

*Color tiles intended for reference only.*

Color	Code	Description
	0	White
	FF	Sea Salt™
	96	Biscuit
	NY	Dune
	95	Ice™ Grey
	58	Thunder™ Grey
	7	Black Black™
	TRF	Truffle
	17	Teal
	42	Aspen Green
	34	Fresh Green



**Iron/Tones®**  
Smart Divide® 33" top-/undermount double-bowl  
kitchen sink  
**K-5312**

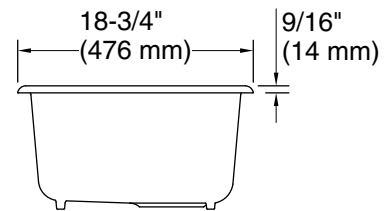
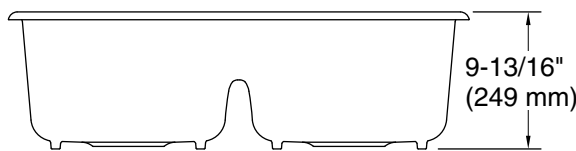
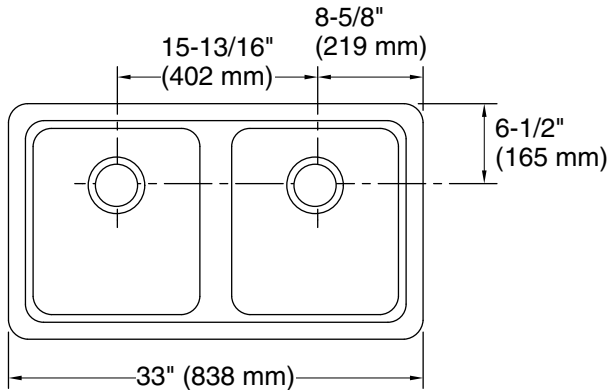

**Technical Information**

All product dimensions are nominal.

Basin configuration: Equal Bowls  
Min. base cabinet width: 36" (914 mm)

Bowl area: Length: 30-5/16" (770 mm)  
Width: 16-1/16" (408 mm)  
Bowl depth: 9" (229 mm)  
Water depth: 9" (229 mm)

Drain hole: 3-7/8" (98 mm)

Template: 1043168-7, required, included

**Notes**

Install this product according to the installation instructions.

Countertop manufacturer or cutter must use the cut-out template provided with the product, or a current one provided by Kohler Co. (call 1-800-43-FOCUS). Kohler Co. is not responsible for cut-out errors when the incorrect cut-out template is used.