



Iron Plains®

18-1/2" rectangular vessel bathroom sink
K-5400-P5

Features

- Rectangular basin
- No faucet holes; requires wall- or counter-mount faucet
- Overflow drain
- Iron Black painted underside

Material

- KOHLER® enameled cast iron

Installation

- Vessel

Recommended Products/Accessories

- K-23726 Drain treatment
- K-23725 Cast iron cleaner

Optional Products/Accessories

- 52047 Clamp Accessory Pack, 4 Ea.

Included Components

- 1193643 Basin clamps



ADA

CSA B651

Codes/Standards





ASME A112.19.1/CSA B45.2
ADA
ICC/ANSI A117.1
CSA B651
IAPMO Certification

KOHLER® Enameled Cast Iron Kitchen and Bathroom Sink Lifetime Limited Warranty

See website for detailed warranty information.

Available Colors/Finishes

Color tiles intended for reference only.

Color	Code	Description
	0	White
	FF	Sea Salt™
	96	Biscuit
	NY	Dune
	7	Black Black™

1-800-4KOHLER (1-800-456-4537)

Kohler Co. reserves the right to make revisions without notice to product specifications.

For the most current Specification Sheet, go to www.kohler.com USA or www.kohler.ca Canada

10-14-2024 21:07 - US/CA

THE BOLD LOOK
OF **KOHLER**®

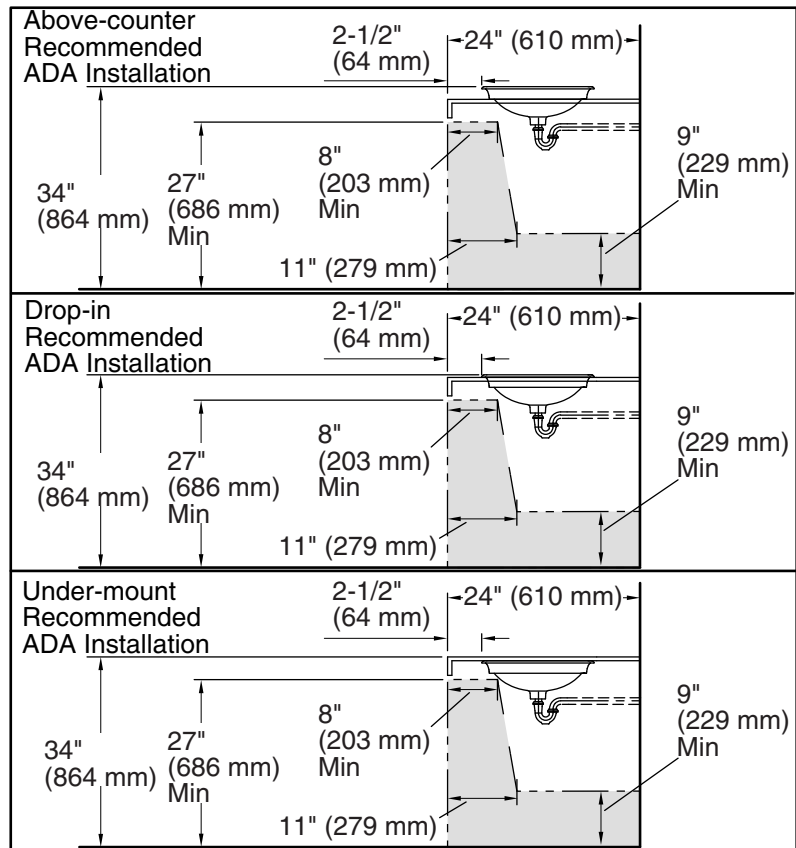
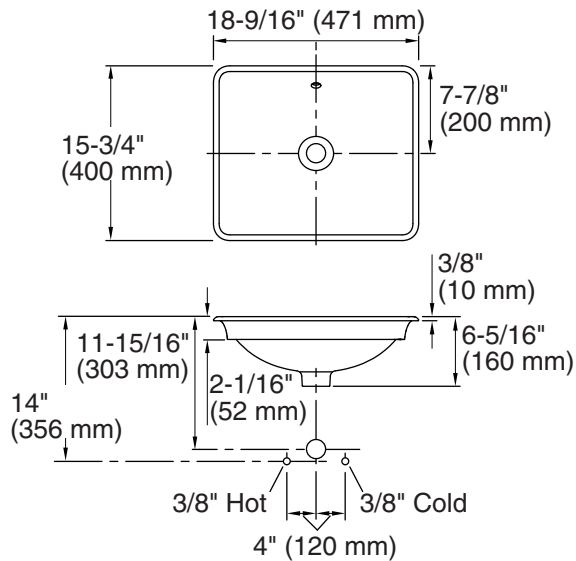

Technical Information

All product dimensions are nominal.

Basin configuration:	Single Bowl
Bowl area (Only):	Length: 17-1/2" (445 mm)
	Width: 14-3/4" (375 mm)
	Bowl depth: 4-9/16" (116 mm)
	Water depth: 2-15/16" (74 mm)
With overflow:	Yes
Template:	1222632-7, required, included

Notes

Install this product according to the installation instructions.

NOTICE: Countertop manufacturer or cutter must use the cut-out template provided with the product, or a current one provided by Kohler Co. (call 1-800-4-KOHLER). Kohler Co. is not responsible for cutout errors when the incorrect cut-out template is used.

ADA, CSA B651 compliant when installed to the specific requirements of these regulations.