

### Features

- 33" (838 mm) minimum base cabinet width for top-mount installation
- 36" (914 mm) minimum base cabinet width for undermount installation
- Single bowl
- 9" (229 mm) depth provides generous workspace

### Material

- KOHLER® enameled cast iron

### Installation

- Top-mount or undermount

### Recommended Products/Accessories

- K-8801 Sink drain and strainer with tailpiece
- K-8799 Sink drain and strainer basket
- K-23726 Drain treatment
- K-23725 Cast iron cleaner
- 1411886 Undermount sink kit 23"

### Optional Products/Accessories

- K-8342 Sink rack for Iron/Tones® kitchen sink
- K-11352 Disposal Flange with Stopper
- K-9000 P-Trap



### Codes/Standards











- ASME A112.19.1/CSA B45.2
- IAPMO Certification

### KOHLER® Enameled Cast Iron Kitchen and Bathroom Sink Lifetime Limited Warranty

See website for detailed warranty information.

### Available Colors/Finishes

*Color tiles intended for reference only.*

Color	Code	Description
	0	White
	FF	Sea Salt™
	96	Biscuit
	NY	Dune
	95	Ice™ Grey
	58	Thunder™ Grey
	7	Black Black™
	TRF	Truffle
	17	Teal
	42	Aspen Green
	34	Fresh Green

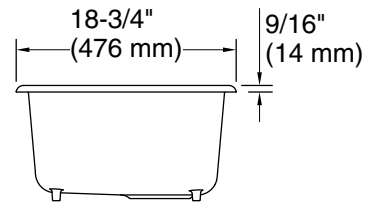
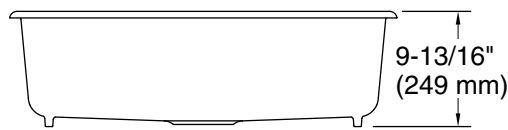
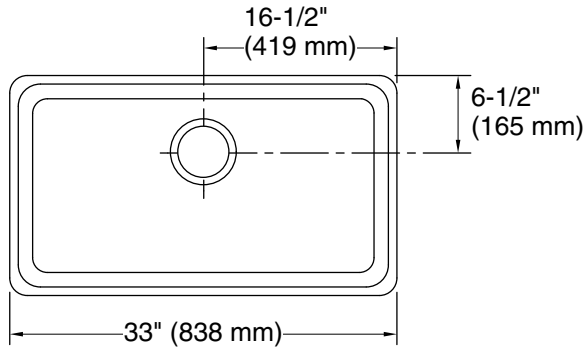

### Technical Information

All product dimensions are nominal.

Basin configuration: Single Bowl

Min. base cabinet width: 36" (914 mm)

Bowl area (Only):  
 Length: 30-5/16" (770 mm)  
 Width: 16-1/16" (408 mm)  
 Bowl depth: 9" (229 mm)  
 Water depth: 9" (229 mm)

Drain hole: 3-7/8" (98 mm)

Template: 1043168-7, required, included

### Notes

Install this product according to the installation instructions.

Countertop manufacturer or cutter must use the cut-out template provided with the product, or a current one provided by Kohler Co. (call 1-800-43-FOCUS). Kohler Co. is not responsible for cut-out errors when the incorrect cut-out template is used.