

Features

- Eight Proflex® hydromassage jets can be individually adjusted for water flow and direction
- Single-speed whirlpool offers performance and value with 8 fully adjustable jets
- Built-in heater
- Slotted overflow allows for deep soaking
- Oval basin creates a spacious bathing experience
- Spacious design accommodates up to two bathers
- Wide ledge on one side is ideal for deck-mount faucet and/or handshower
- Integral lumbar support
- Textured bottom surface

Material

- Acrylic

Installation

- Drop-in or undermount
- Center drain

Required Products/Accessories

K-7271 Brass Slotted Overflow Bath Drain

or

K-7272 PVC Slotted Overflow Bath Drain

Recommended Products/Accessories

K-1491 Bath/Whirlpool Pillow

K-1601 Bath/whirlpool footstop, removable

K-1177 Vinyl Tiling-in Bead

K-886 Under-Mount Installation Kit



Codes/Standards

ASME A112.19.7/CSA B45.10

CSA B45.5/IAPMO Z124

ASTM E162

ASTM E662

UL 1795

CSA C22.2 No. 218.2

IAPMO Certification

cUL Listed







UL Listed

KOHLER® Plastic Baths and Shower Bases Lifetime Limited Warranty KOHLER® Hydrotherapy Components Five-Year Limited Warranty

See website for detailed warranty information.

Available Colors/Finishes

Color tiles intended for reference only.

Color	Code	Description
	0	White
	96	Biscuit
	NY	Dune
	95	Ice™ Grey
	58	Thunder™ Grey
	7	Black Black™

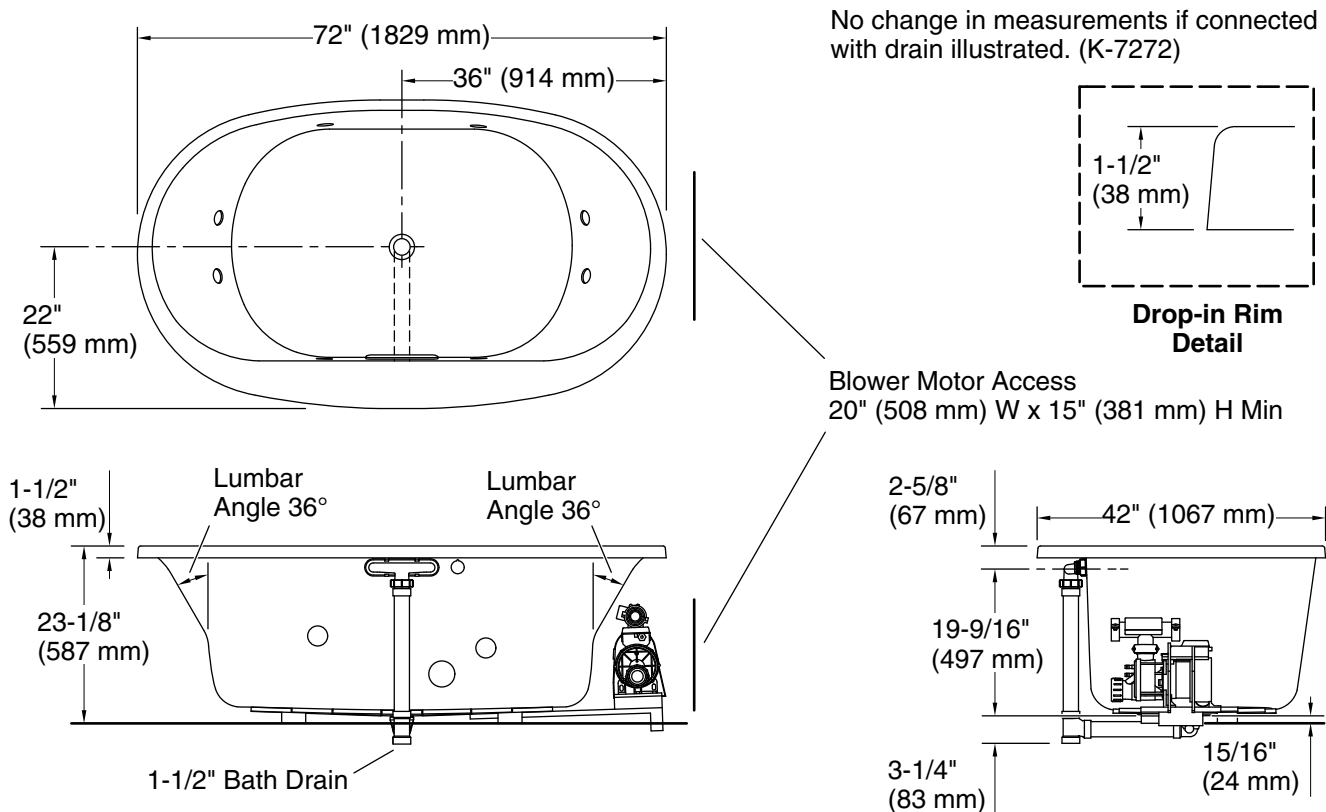

Required Electrical Service

Two dedicated circuits required, protected with Class A Ground-Fault Circuit-Interrupter (GFCI). Outside North America, this device may be known as a Residual Current Device (RCD).

Pump: 120 V, 15 A, 60 Hz
Heater: 120 V, 15 A, 60 Hz

Technical Information

All product dimensions are nominal.

Drain location: Center
Basin area, bottom: 46-3/8" x 31-3/16" (1178 mm x 792 mm)
Basin area, top: 67-3/4" x 35-3/8" (1721 mm x 899 mm)
Weight: 115 lbs (52.2 kg)
Minimum floor load: 54.6 lbs/ft² (266.6 kg/m²)
Water depth: 18-7/16" (469 mm)
Water capacity: 111 gal (420.2 L)
Electrical component rating: Pump: 120 V, 7 A, 60 Hz
Heater: 120 V, 12 A, 60 Hz

Notes

Measure your actual product for rough-in details.

Install this product according to the installation instructions.

The hot water supply should be 70% of the capacity of the bath or greater. Installations will vary.