

Features

- 28" minimum base cabinet width
- Single bowl
- 9" (229 mm) depth provides generous workspace
- Five oversized faucet holes
- Oversized holes allow for easy installation of faucets and accessories
- Bowl slopes toward drain to minimize water pooling
- Offset drain increases workspace in the sink and storage space underneath
- Small size fits compact spaces
- Sink drain with strainer sold separately

Material

- KOHLER® enameled cast iron

Installation

- Undermount
- Undermount installation kit not included

Recommended Products/Accessories

- K-8801 Sink drain and strainer with tailpiece
- K-8799 Sink drain and strainer basket
- K-11352 Disposal Flange with Stopper
- K-9000 P-Trap
- 1411886 Undermount sink kit 23"
- K-23726 Drain treatment
- K-23725 Cast iron cleaner
- K-35000 Three-piece workstation sink accessory set
- K-35001 Maple wood cutting board
- K-35002 Ice bucket holder
- K-35003 Workstation sink cover
- K-35005 Marble serving tray
- K-35487 Three-piece ice bucket set
- K-35484 Three-piece workstation sink prep bowl set

Included Components

- K-6238 Sink Rack



Codes/Standards









ASME A112.19.1/CSA B45.2
IAPMO Certification

KOHLER® Enameled Cast Iron Kitchen and Bathroom Sink Lifetime Limited Warranty

See website for detailed warranty information.

Available Colors/Finishes

Color tiles intended for reference only.

Color	Code	Description
	0	White
	FF	Sea Salt™
	96	Biscuit
	NY	Dune
	95	Ice™ Grey
	58	Thunder™ Grey
	7	Black Black™
	TRF	Truffle

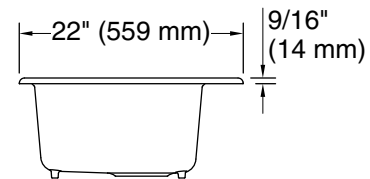
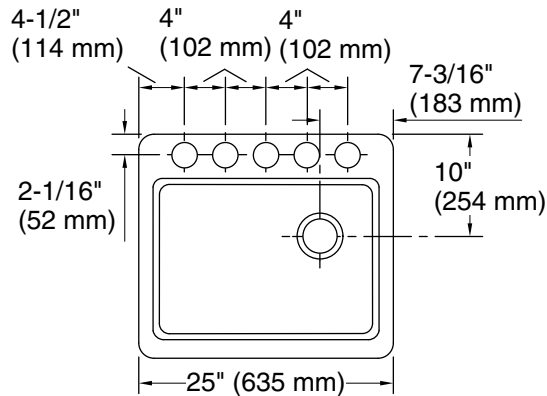

Technical Information

All product dimensions are nominal.

Basin configuration: Single Bowl
Min. base cabinet width: 28" (711 mm)

Bowl area (Only): Length: 22-1/4" (565 mm)
Width: 15-13/16" (402 mm)
Bowl depth: 9" (229 mm)

Number of deck holes: 5

Faucet hole(s): 2-3/8" (60 mm)

Drain hole: 3-7/8" (98 mm)

Template: 1172565-7, required, included

Notes

Install this product according to the installation instructions.

NOTICE: Countertop manufacturer or cutter must use the cut-out template provided with the product, or a current one provided by Kohler Co. (call 1-800-4-KOHLER). Kohler Co. is not responsible for cutout errors when the incorrect cut-out template is used.

IMPORTANT! Use of the colander, wood cutting board, and utility rack requires the "reveal" cutout option on the cutout template.