



Whitehaven®

Smart Divide® 35-1/2" undermount double-bowl
farmhouse kitchen sink with short apron
K-6426

Features

- 36" minimum base cabinet width
- Large/medium bowls
- 9" (229 mm) depth provides generous workspace
- Shortened apron allows sink to be used in most standard cabinetry or retrofitted to existing standard cabinetry
- Self-Trimming® apron overlaps cabinet face for easy installation and beautiful results
- Smart Divide® feature offers a lower bowl divider that increases workspace versatility
- Bowl slopes toward drain to minimize water pooling
- Offset drain increases workspace in the sink and storage space underneath

Material

- KOHLER® enameled cast iron

Installation

- Undermount

Recommended Products/Accessories

- K-5828 Sink Rack
- K-5874 Sink Rack
- K-8801 Sink drain and strainer with tailpiece
- K-8799 Sink drain and strainer basket
- K-23726 Drain treatment
- K-23725 Cast iron cleaner

Optional Products/Accessories

- K-11352 Disposal Flange with Stopper
- K-9000 P-Trap



Codes/Standards











ASME A112.19.1/CSA B45.2

KOHLER® Enameled Cast Iron Kitchen and Bathroom Sink Lifetime Limited Warranty

See website for detailed warranty information.

Available Colors/Finishes

Color tiles intended for reference only.

Color	Code	Description
	0	White
	FF	Sea Salt™
	96	Biscuit
	NY	Dune
	95	Ice™ Grey
	58	Thunder™ Grey
	7	Black Black™
	TRF	Truffle
	17	Teal
	34	Fresh Green
	42	Aspen Green

1-800-4KOHLER (1-800-456-4537)

Kohler Co. reserves the right to make revisions without notice to product specifications.

For the most current Specification Sheet, go to www.kohler.com USA or www.kohler.ca Canada

12-10-2024 21:18 - US/CA

THE BOLD LOOK
OF **KOHLER**®

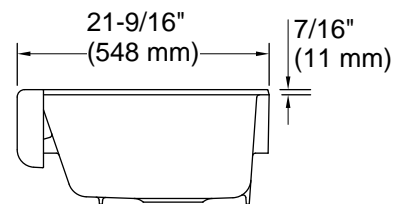
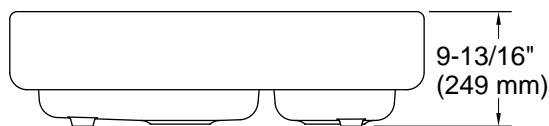
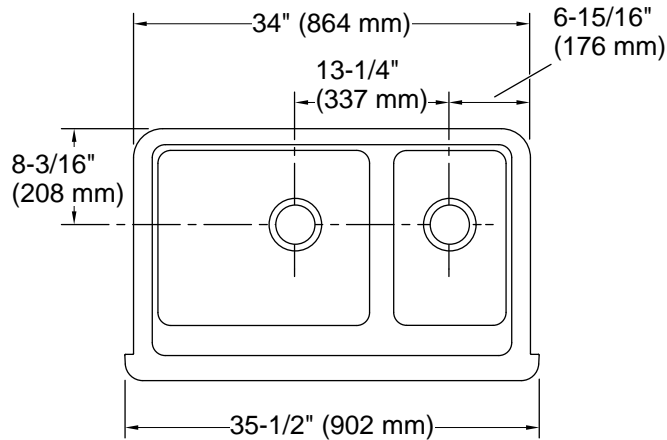

Technical Information

All product dimensions are nominal.

Basin configuration: Large Bowl on Left

Min. base cabinet width: 36" (914 mm)

Bowl area (Basin #1):
 Length: 18-13/16" (478 mm)
 Width: 18-1/16" (459 mm)
 Bowl depth: 9" (229 mm)
 Water depth: 4-1/2" (114 mm)

Bowl area (Basin #2):
 Length: 10-5/16" (262 mm)
 Width: 18-1/16" (459 mm)
 Bowl depth: 9" (229 mm)
 Water depth: 4-1/2" (114 mm)

Drain hole: 3-5/8" (92 mm)

Notes

Install this product according to the installation instructions.

NOTICE: The countertop manufacturer or cutter must use the cut-out template provided with the product, or a current one provided by Kohler Co. (call 1-800-4KOHLER). Kohler Co. is not responsible for cut-out errors when the incorrect cut-out template is used.

IMPORTANT! The distance from the top edge of the cabinet to the top of the cabinet door must be at least 6-7/8" (175 mm) to install this sink.