

Features

- 36" minimum base cabinet width
- Single bowl
- 9" (229 mm) depth provides generous workspace
- Shortened apron allows sink to be used in most standard cabinetry or retrofitted to existing standard cabinetry
- Self-Trimming® apron overlaps cabinet face for easy installation and beautiful results
- Bowl slopes toward drain to minimize water pooling
- Offset drain increases workspace in the sink and storage space underneath

Material

- KOHLER® enameled cast iron

Installation

- Undermount

Required Products/Accessories

K-6639 Sink racks for 36" Whitehaven®

or

K-8801 Sink drain and strainer with tailpiece

or

K-8799 Sink drain and strainer basket

or

K-11352 Disposal Flange with Stopper

Recommended Products/Accessories

K-23726 Drain treatment

K-23725 Cast iron cleaner

Optional Products/Accessories

K-9000 P-Trap



Codes/Standards

ASME A112.19.1/CSA B45.2











IAPMO Certification

KOHLER® Enameled Cast Iron Kitchen and Bathroom Sink Lifetime Limited Warranty

See website for detailed warranty information.

Available Colors/Finishes

Color tiles intended for reference only.

Color	Code	Description
	0	White
	FF	Sea Salt™
	96	Biscuit
	NY	Dune
	95	Ice™ Grey
	58	Thunder™ Grey
	7	Black Black™
	TRF	Truffle
	17	Teal
	42	Aspen Green
	34	Fresh Green

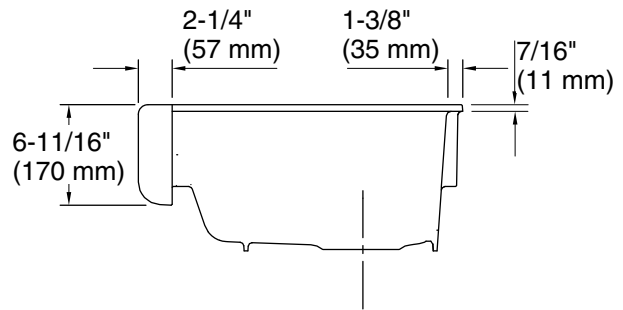
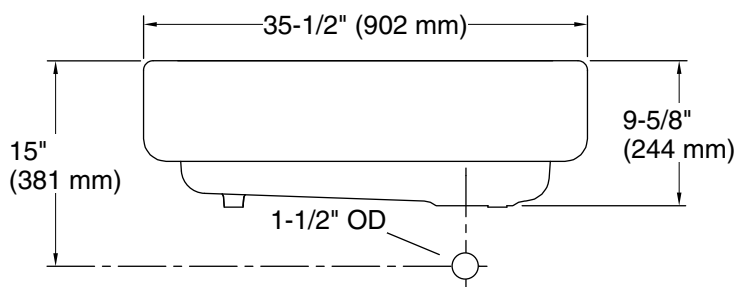
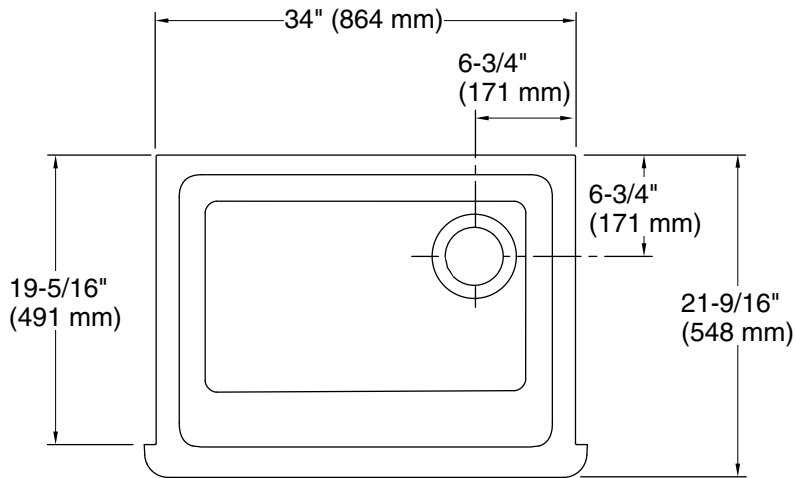

Technical Information

All product dimensions are nominal.

Basin configuration: Single Bowl
 Min. base cabinet width: 36" (914 mm)

Bowl area (Only): Length: 30-3/4" (781 mm)
 Width: 18-1/16" (459 mm)
 Bowl depth: 9" (229 mm)

Drain hole: 3-5/8" (92 mm)

Template: 1156910-7, required, included
 1211449-7, required, included

Notes

Install this product according to the installation instructions.

NOTICE: Countertop manufacturer or cutter must use the current product template available at www.kohler.com, or by calling 1-800-4KOHLER. Kohler Co. is not responsible for cutout errors when the incorrect cutout template is used.

IMPORTANT! The distance from the top edge of the cabinet to the top of the cabinet door must be at least 6-7/8" (175 mm) to install this sink.