

### Features

- Frameless 1/4" (6 mm) thick frosted tempered glass
- Innovative roller design simplifies installation and provides out-of-plumb adjustability while glass is installed
- Cushioned center guide provides smooth, quiet sliding action
- Gently curved towel bars, inside and outside, provide integrated storage on the door
- CleanCoat®+ glass coating creates a hydrophobic barrier that repels water, soap scum, and residue, saving time and protecting shower doors 10 times longer than original CleanCoat. (Based on 2021 internal wear/abrasion testing using a microfiber cloth.)
- Tempered glass ensures enhanced safety and durability

### Installation

- Sliding bath door
- Not for use in hospitality



### Codes/Standards

ANSI Z97.1  
CAN/CGSB-12.1  
CPSC 16CFR 1201

### KOHLER® Bath and Shower Doors Ten-Year Limited Warranty

See website for detailed warranty information.

### Available Colors/Finishes

*Color tiles intended for reference only.*

Color	Code	Description
	SH	Bright Silver
	MX	Matte Nickel
	ABV	Anodized Brushed Bronze
	ABZ	Anodized Dark Bronze
	BL	Matte Black

### Available Glass Options

Code	Description
D3	Frosted

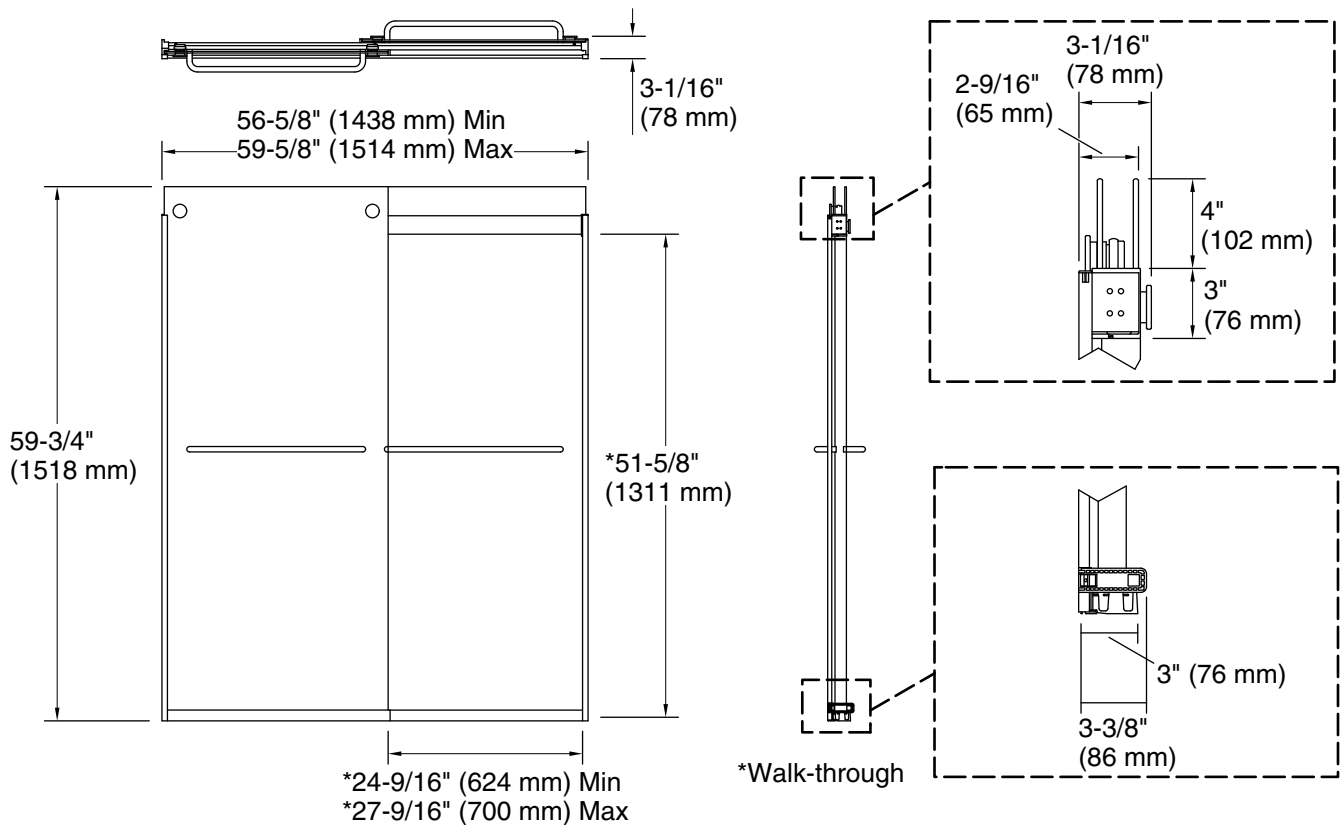

## Technical Information

All product dimensions are nominal.

Base-To-Wall	1/2" (13 mm)
Radius – Max:	
Shower Ledge Min	3" (76 mm)
Flat:	
Shower Wall Min	3-1/2" (89 mm)
Flat:	

## Notes

Install this product according to the installation guide.

If replacing a shower door, the narrow wall jamb design of this door may not cover the existing shower door holes.

The vertical opening should be a minimum of 62-1/4" (1581 mm) to allow for installation clearance.