

Features

- Frameless, heavy 5/16" (8 mm) thick Frosted tempered glass
- 63-9/16" (1614 mm) high, with 57-1/2" (1460 mm) minimum head clearance
- Frameless design emphasizes glass and creates a sleek, minimalist look
- Double header conceals wheels and door tracking system while allowing glass panels to rise above the header, giving the door a lofted and airy look
- Stays Closed feature inside the header keeps door firmly closed, providing excellent water containment
- Smooth, easy-to-clean wall jambs
- 16" vertical handles
- CleanCoat®+ glass coating creates a hydrophobic barrier that repels water, soap scum, and residue, saving time and protecting shower doors 10 times longer than original CleanCoat. (Based on 2021 internal wear/abrasion testing using a microfiber cloth.)
- Innovative roller design simplifies installation and provides out-of-plumb adjustability while glass is installed

Material

- Anodized aluminum prevents rust and corrosion

Installation

- Fits opening widths 54-5/8" – 59-5/8" (1387 – 1514 mm)
- Out-of-plumb adjustability simplifies installation
- Door can be installed to open to the left or right to suit your bathroom layout
- Not for use in hospitality
- For residential use only



Codes/Standards

ANSI Z97.1
CAN/CGSB-12.1
CPSC 16CFR 1201

KOHLER® Bath and Shower Doors Ten-Year Limited Warranty

See website for detailed warranty information.

Available Colors/Finishes

Color tiles intended for reference only.

Color	Code	Description
	SHP	Bright Polished Silver
	BL	Matte Black
	BNK	Anodized Brushed Nickel

Available Glass Options

Code	Description
D3	Frosted

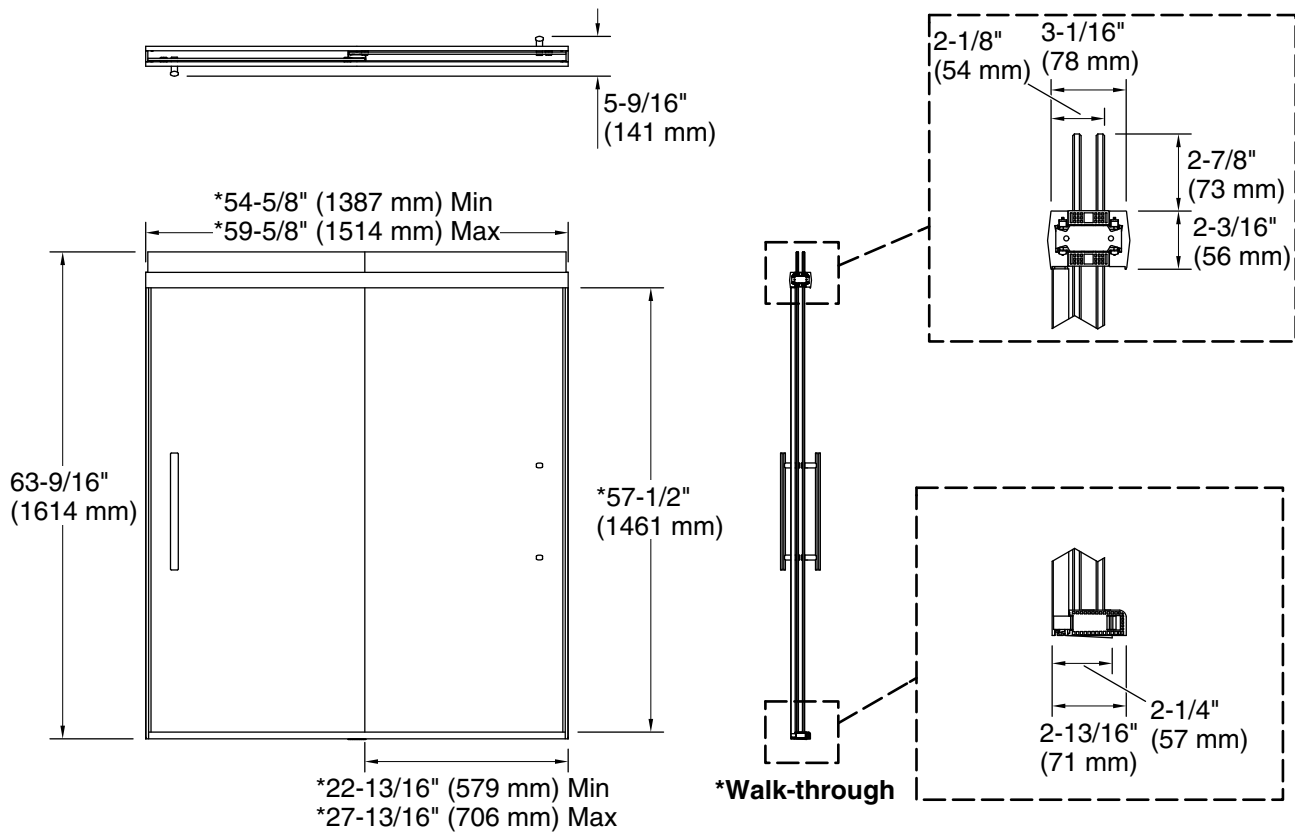

Technical Information

All product dimensions are nominal.

Base-To-Wall	1/4" (6 mm)
Radius – Max:	
Shower Ledge Min	2-1/2" (64 mm)
Flat:	
Shower Wall Min	3-1/16" (78 mm)
Flat:	

Notes

Install this product according to the installation instructions.

If replacing a shower door, the narrow wall jamb design of this door may not cover the existing shower door holes.

This product can only be installed with a corner radius between the shower wall and the shower/bath ledge of 1/4" (6 mm) or less.

The vertical opening should be a minimum of 65-1/2" (1664 mm) to allow for installation clearance.