

Features

- 58-1/4" (1480 mm) high, with no minimum head clearance restriction
- Frameless design emphasizes glass and creates a sleek, minimalist look
- Innovative L- bracket secures the fixed panel in place and gives it a sturdy feel while also being unobtrusive to the showering space
- SealNetik™ full-length magnetic seal keeps door firmly closed, providing excellent water containment
- Smooth, easy-to-clean wall jambs
- Back-to-back 11-1/2" (292 mm) vertical handles
- CleanCoat®+ glass coating creates a hydrophobic barrier that repels water, soap scum, and residue, saving time and protecting shower doors 10 times longer than original CleanCoat. (Based on 2021 internal wear/abrasion testing using a microfiber cloth.)

Material

- Frameless, heavy 5/16" (8 mm) thick Crystal Clear tempered glass
- Anodized aluminum prevents rust and corrosion

Installation

- Fits opening widths 55-3/4" – 59-3/4" (1416 – 1518 mm)
- Requires 1-3/4" (44.5 mm) minimum threshold depth
- Requires minimum of 5-1/2" (140 mm) flat wall on fixed-panel side to mount L-bracket
- 3/8" (10-mm) out-of-plumb adjustability on each side simplifies installation
- Door can be installed to open to the left or right to suit your bathroom layout
- Not for use in hospitality
- For residential use only



Codes/Standards

ANSI Z97.1
CAN/CGSB-12.1
CPSC 16CFR 1201

KOHLER® Bath and Shower Doors Ten-Year Limited Warranty

See website for detailed warranty information.

Available Colors/Finishes

Color tiles intended for reference only.

Color	Code	Description
	SHP	Bright Polished Silver
	BL	Matte Black
	BNK	Anodized Brushed Nickel

Available Glass Options

Code	Description
L	Crystal Clear

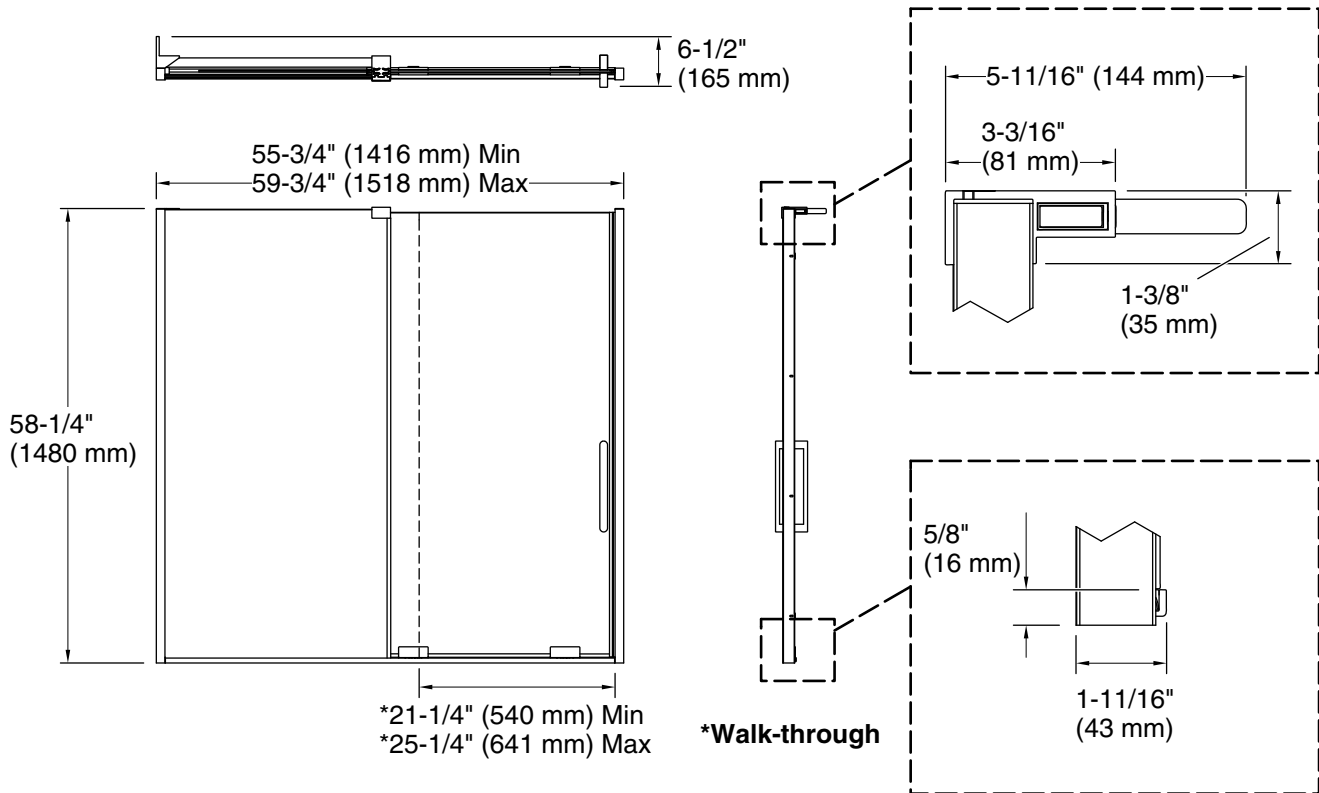

Technical Information

All product dimensions are nominal.

Base-To-Wall	1/4" (6 mm)
Radius – Max:	
Shower Ledge Min	1-3/4" (44 mm)
Flat:	
Shower Wall Min	5-1/2" (140 mm)
Flat:	
Wall Studs Required	Yes
for Door:	

Notes

Install this product according to the installation instructions.

The vertical opening should be a minimum of 59-5/8" (1514 mm) to allow for installation clearance.