

Features

- Metal pop-up drain with tailpiece
- 6-5/8" (168 mm) spout reach
- Includes stationary spout with aerator and pop-up drain with 1-1/4" tailpiece
- Handles sold separately
- Laminar flow
- 1.2 gpm (4.5 lpm) maximum flow rate at 60 psi (4.14 bar)
- Coordinate with your choice of Artifacts handles for a personalized design
- This product can help a building earn Water Efficiency points in LEED® Green Building Rating System

Material

- Brass
- KOHLER finishes resist corrosion and tarnishing

Installation

- Widespread

Required Products/Accessories

K-98068-3 Cross bathroom sink faucet handles

or

K-98068-4 Lever bathroom sink faucet handles

Recommended Products/Accessories

- K-23726 Drain treatment
- K-23723 Faucet cleaner
- K-72567 18" Towel Bar
- K-72568 24" Towel Bar
- K-72570 24" Double Towel Bar
- K-72571 Towel Ring
- K-72572 Robe Hook
- K-72573 Pivoting toilet paper holder
- K-72576 Toilet paper carriage



Codes/Standards

ASME A112.18.1/CSA B125.1

NSF/ANSI/CAN 61











NSF/ANSI/CAN 372

KOHLER® Faucet Lifetime Limited Warranty

See website for detailed warranty information.

Available Colors/Finishes

Color tiles intended for reference only.

Color	Code	Description
	CP	Polished Chrome
	SN	Vibrant® Polished Nickel
	AF	Vibrant® French Gold
	BN	Vibrant® Brushed Nickel
	BV	Vibrant® Brushed Bronze
	2BZ	Oil-Rubbed Bronze
	BL	Matte Black
	2MB	Vibrant® Brushed Moderne Brass
	TT	Vibrant Titanium
	DR	Deep Bronze

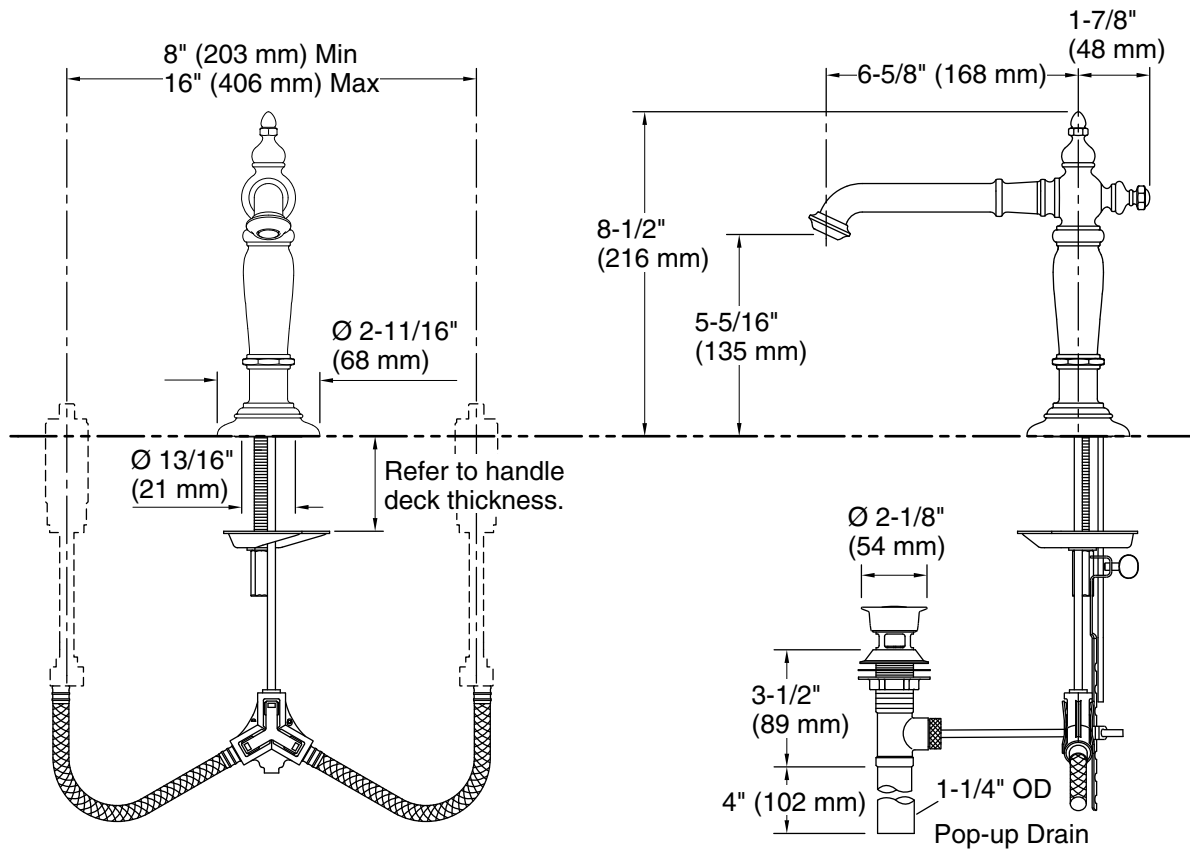

Technical Information

All product dimensions are nominal.

Faucet flow rate: 1.2 gal/min (4.5 l/min)

Drain included: Yes

Spout:

Spout reach: 6-5/8" (168 mm)

Notes

Install this product according to the installation instructions.