

## Features

- Metal construction

## Installation

- Wall-mount installation with slip-fit connection and NPT threads

## Recommended Products/Accessories

- K-72567 18" Towel Bar
- K-72568 24" Towel Bar
- K-72570 24" Double Towel Bar
- K-72571 Towel Ring
- K-72572 Robe Hook
- K-72573 Pivoting toilet paper holder
- K-72576 Toilet paper carriage



## Codes/Standards







ASME A112.18.1/CSA B125.1

## KOHLER® Faucet Lifetime Limited Warranty

See website for detailed warranty information.

## Available Colors/Finishes

*Color tiles intended for reference only.*

Color	Code	Description
	CP	Polished Chrome
	SN	Vibrant® Polished Nickel
	AF	Vibrant® French Gold
	BN	Vibrant® Brushed Nickel
	BV	Vibrant® Brushed Bronze
	BL	Matte Black
	2MB	Vibrant® Brushed Moderne Brass
	TT	Vibrant Titanium

For slip-fit spout, 5/8" OD tube  
must extend 2-1/2" (64 mm)  
beyond finished wall.  
For threaded spout, 1/2" NPT pipe  
must extend 1-3/4" (44 mm)  
beyond finished wall.

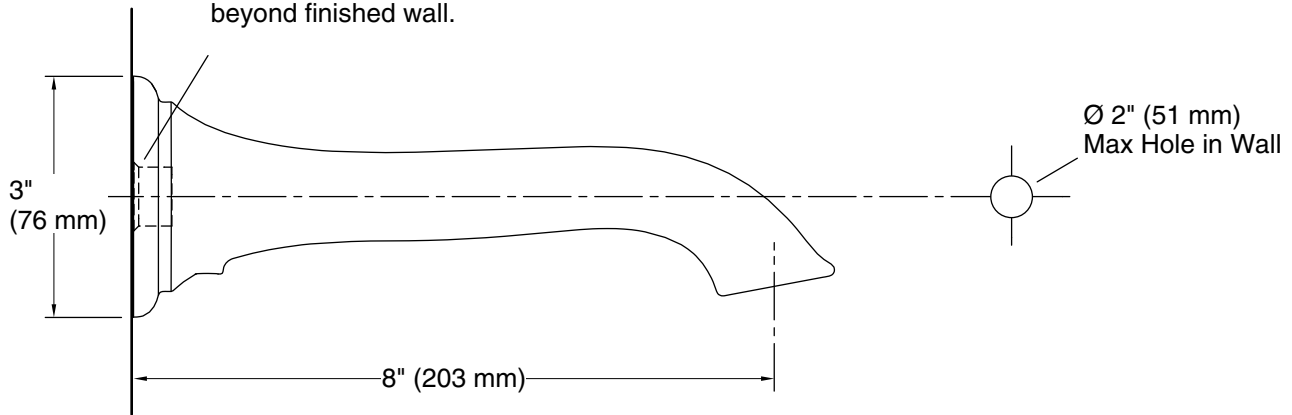

### Technical Information

All product dimensions are nominal.

#### Spout:

Spout reach: 8" (203 mm)

### Notes

Install this product according to the installation instructions.