

Features

- Handshower holder pivots and rotates to position handshower at desired angle
- For use with a handshower and hose (sold separately)
- Includes check valve for backflow prevention
- Includes supply elbow. Integrated supply and holder reduces the number of components needed in the shower space, allowing for a cleaner look
- Coordinates with other products in the Artifacts collection

Material

- Premium metal construction for durability and reliability
- KOHLER finishes resist corrosion and tarnishing

Installation

- Wall-mount

Recommended Products/Accessories

K-23723 Faucet cleaner



Codes/Standards



ASME A112.18.1/CSA B125.1

KOHLER® Faucet Lifetime Limited Warranty

See website for detailed warranty information.

Available Colors/Finishes

Color tiles intended for reference only.

Color	Code	Description
	CP	Polished Chrome
	SN	Vibrant® Polished Nickel
	AF	Vibrant® French Gold
	BN	Vibrant® Brushed Nickel
	BV	Vibrant® Brushed Bronze
	2BZ	Oil-Rubbed Bronze
	TT	Vibrant Titanium
	DR	Deep Bronze

For NPT connection,
nipple must extend
11/16" (17 mm) beyond
finished wall.

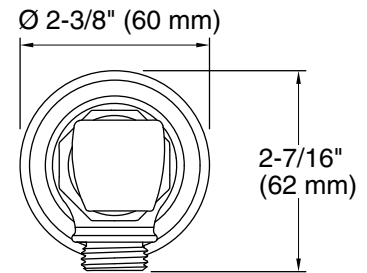
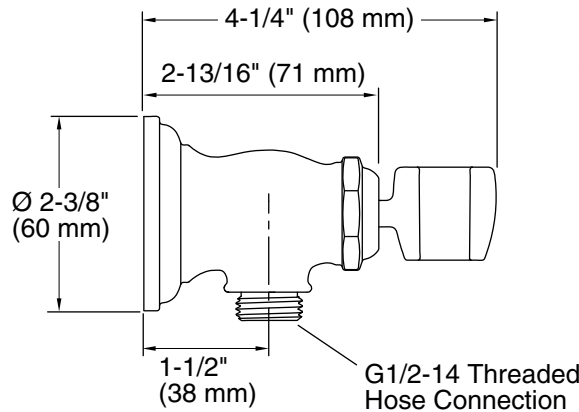
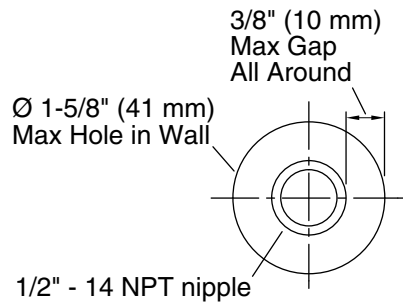
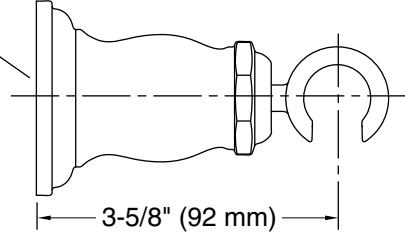

Technical Information

All product dimensions are nominal.

Material: Metal

Notes

Install this product according to the installation guide.

Installs using a 1/2"-14 NPT nipple (not supplied).