

# KOHLER® Faucets

Widespread bathroom sink faucet with Cross handles,  
1.2 gpm  
**K-73060-3**

**Composed®**

## Features

- Two cross handles allow for both volume and temperature control
- Includes pop-up drain with 1-1/4" (32 mm) tailpiece
- 1.2 gpm (4.5 lpm) maximum flow rate at 60 psi (4.14 bar)
- 3-7/8" (98 mm) spout reach
- 5-15/16" (151 mm) spout reach
- KOHLER® ceramic disc valves exceed industry longevity standards for a lifetime of durable performance
- Coordinates with Composed faucets, accessories, and showering components to complete your bathroom
- Low-flow aerator option available

## Material

- Premium metal construction for durability and reliability
- KOHLER® finishes resist corrosion and tarnishing

## Installation

- Handles are preassembled on valves to simplify installation
- For 8" – 16" (203 – 406 mm) centers
- Widespread

## Recommended Products/Accessories

- K-23726 Drain treatment
- K-23723 Faucet cleaner
- K-73141 18" Towel Bar
- K-73142 24" Towel Bar
- K-73144 24" Double Towel Bar
- K-73145 towel arm
- K-73146 Double Robe Hook
- K-73147 Pivoting toilet paper holder
- K-73148 Vertical toilet paper holder



## Codes/Standards







ASME A112.18.1/CSA B125.1  
All applicable US Federal and State material regulations  
DOE - Energy Policy Act 1992  
EPA WaterSense®  
California Energy Commission (CEC)  
ADA  
ICC/ANSI A117.1  
IAPMO Certification

## KOHLER® Faucet Lifetime Limited Warranty

See website for detailed warranty information.

## Available Colors/Finishes

*Color tiles intended for reference only.*

Color	Code	Description
	CP	Polished Chrome
	SN	Vibrant® Polished Nickel
	AF	Vibrant® French Gold
	BN	Vibrant® Brushed Nickel
	BV	Vibrant® Brushed Bronze
	BL	Matte Black
	2MB	Vibrant® Brushed Moderne Brass
	TT	Vibrant Titanium

1-800-4KOHLER (1-800-456-4537)

Kohler Co. reserves the right to make revisions without notice to product specifications.

For the most current Specification Sheet, go to [www.kohler.com](http://www.kohler.com) USA or [www.kohler.ca](http://www.kohler.ca) Canada

10-21-2024 23:54 - US/CA

THE BOLD LOOK  
OF **KOHLER®**

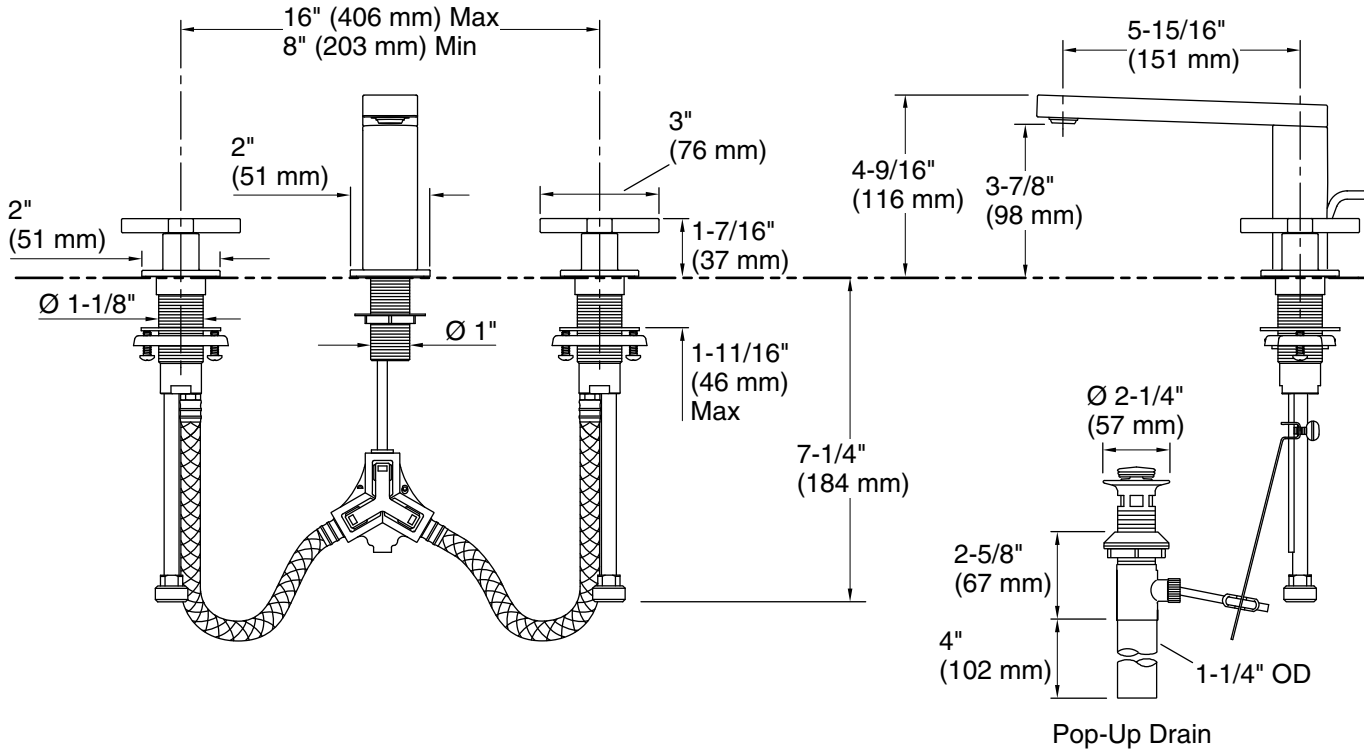

## Technical Information

All product dimensions are nominal.

### Faucet:

Flow rate: 1.2 gal/min (4.5 l/min)

Drain included: Yes

Drain with overflow: Yes

### Spout:

Spout reach: 5-15/16" (151 mm)

### Handshower:

Rated maximum flow: 0 gal/min (0 l/min)

## Notes

Install this product according to the installation guide.

ADA compliant for handles only.

ADA compliant when installed to the specific requirements of these regulations.