

Features

- Two Lever handles offer separate control of hot and cold water
- 1.2 gpm (4.5 lpm) maximum flow rate at 60 psi (4.14 bar)
- 5-15/16" (151 mm) spout reach
- UltraGlide® valves with dry-stem technology are designed to eliminate common leak paths and provide smooth, effortless control
- Includes pop-up drain with 1-1/4" (32 mm) tailpiece
- Coordinates with Composed faucets, accessories, and showering components to complete your bathroom

Material

- Premium metal construction for durability and reliability
- KOHLER® finishes resist corrosion and tarnishing

Installation

- For 8" – 16" (203 – 406 mm) centers
- Handles are preassembled on valves to simplify installation
- Quick-connect fittings make installation easy

Recommended Products/Accessories

- K-23726 Drain treatment
- K-23723 Faucet cleaner
- K-73141 18" Towel Bar
- K-73142 24" Towel Bar
- K-73144 24" Double Towel Bar
- K-73145 towel arm
- K-73146 Double Robe Hook
- K-73147 Pivoting toilet paper holder
- K-73148 Vertical toilet paper holder



Codes/Standards





ASME A112.18.1/CSA B125.1
NSF/ANSI/CAN 61
NSF/ANSI/CAN 372
All applicable US Federal and State material regulations
DOE - Energy Policy Act 1992
EPA WaterSense®
California Energy Commission (CEC)
ADA
ICC/ANSI A117.1
CSA B651
OBC
IAPMO Certification

KOHLER® Faucet Lifetime Limited Warranty

See website for detailed warranty information.

Available Colors/Finishes

Color tiles intended for reference only.

| Color | Code | Description |
|---|------|--------------------------|
|  | CP | Polished Chrome |
|  | SN | Vibrant® Polished Nickel |
|  | AF | Vibrant® French Gold |
|  | BN | Vibrant® Brushed Nickel |
|  | BV | Vibrant® Brushed Bronze |

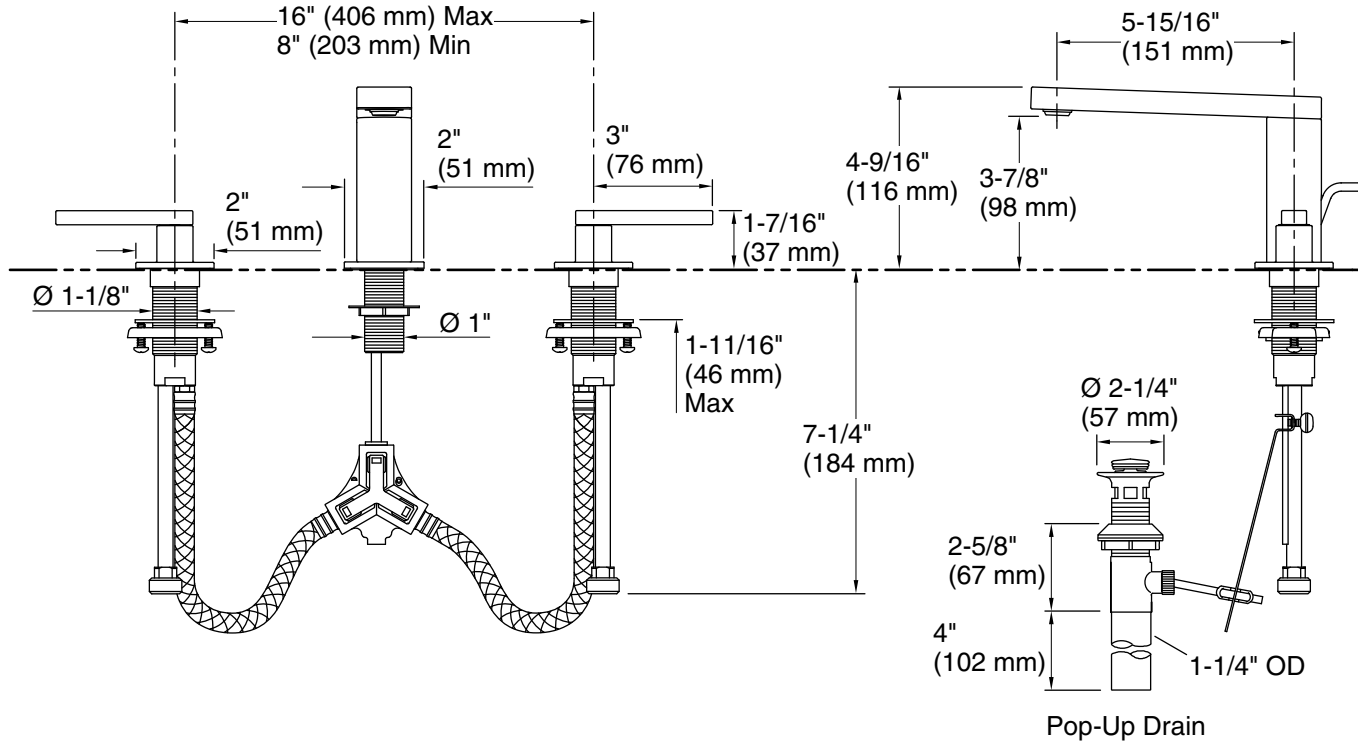

Technical Information

All product dimensions are nominal.

Faucet:

Flow rate: 1.2 gal/min (4.5 l/min)

Drain included: Yes

Drain with overflow: Yes

Spout:

Spout reach: 5-15/16" (151 mm)

Handshower:

Rated maximum flow: 0 gal/min (0 l/min)

Notes

Install this product according to the installation guide.

ADA compliant for handles only.

ADA, OBC, CSA B651 compliant when installed to the specific requirements of these regulations.