

## Features

- Compression valve
- Annealed vertical tube with supply flange
- 1/2" NPT connection with flange
- Four-arm handle stop

## Material

- Brass

## Recommended Products/Accessories

K-23723 Faucet cleaner



## Codes/Standards









ASME A112.18.1/CSA B125.1  
IAPMO Certification

## KOHLER® One-Year Limited Warranty

See website for detailed warranty information.

## Available Colors/Finishes

*Color tiles intended for reference only.*

Color	Code	Description
	CP	Polished Chrome
	SN	Vibrant® Polished Nickel
	AF	Vibrant® French Gold
	PB	Vibrant® Polished Brass
	BN	Vibrant® Brushed Nickel
	BV	Vibrant® Brushed Bronze
	BL	Matte Black
	2MB	Vibrant® Brushed Moderne Brass
	TT	Vibrant Titanium

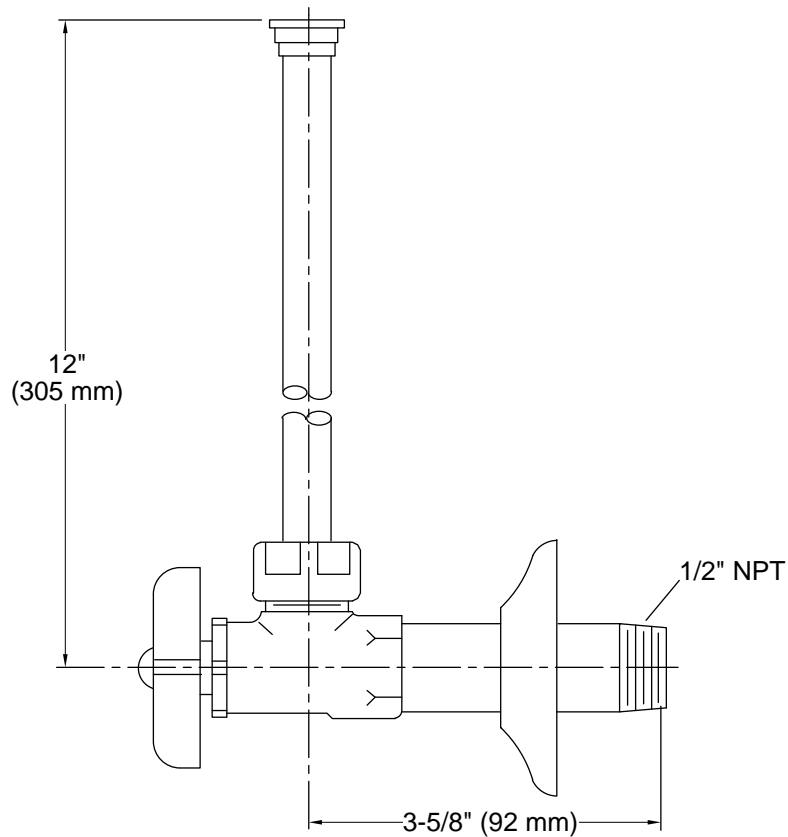

### Technical Information

All product dimensions are nominal.

#### Spout:

#### Handshower:

Rated maximum flow: 0 gal/min (0 l/min)

### Notes

Install this product according to the installation guide.