

### Features

- Single Rocker handle allows for both volume and temperature control
- For use with Components K-77967, K-77965, K-77968, K-77966, or K-77969 spout (sold separately)
- Coordinates with Components faucets, accessories, and showering components to complete your bathroom
- KOHLER® ceramic disc valves exceed industry longevity standards for a lifetime of durable performance

### Material

- Premium metal construction for durability and reliability
- KOHLER® finishes resist corrosion and tarnishing

### Installation

- Single-hole mounting
- Remote valve installation allows flexibility for placement
- Preattached flexible supply lines simplify installation

### Required Products/Accessories

- K-77965 Bathroom sink faucet spout with Tube design, 1.2 gpm
- or
- K-77966 Bathroom sink faucet spout with Ribbon design, 1.2 gpm
- or
- K-77967 Bathroom sink faucet spout with Tube design, 1.2 gpm
- or
- K-77968 Bathroom sink faucet spout with Ribbon design, 1.2 gpm
- or
- K-77969 Bathroom sink faucet spout with Row design, 1.2 gpm

### Recommended Products/Accessories

- K-23887 Bathroom sink faucet spout with Row design, 1.2 gpm
- K-23723 Faucet cleaner



**ADA** **CSA B651** **OBC**

### Codes/Standards









ASME A112.18.1/CSA B125.1  
 NSF/ANSI/CAN 61  
 NSF/ANSI/CAN 372  
 All applicable US Federal and State material regulations  
 ADA  
 ICC/ANSI A117.1  
 CSA B651  
 OBC  
 IAPMO Certification

### KOHLER® Faucet Lifetime Limited Warranty

See website for detailed warranty information.

### Available Colors/Finishes

*Color tiles intended for reference only.*

| Color   | Code | Description                    |
|---|------|--------------------------------|
|  | CP   | Polished Chrome                |
|  | SN   | Vibrant® Polished Nickel       |
|  | AF   | Vibrant® French Gold           |
|  | BN   | Vibrant® Brushed Nickel        |
|  | BV   | Vibrant® Brushed Bronze        |
|  | BL   | Matte Black                    |
|  | 2MB  | Vibrant® Brushed Moderne Brass |
|  | TT   | Vibrant Titanium               |

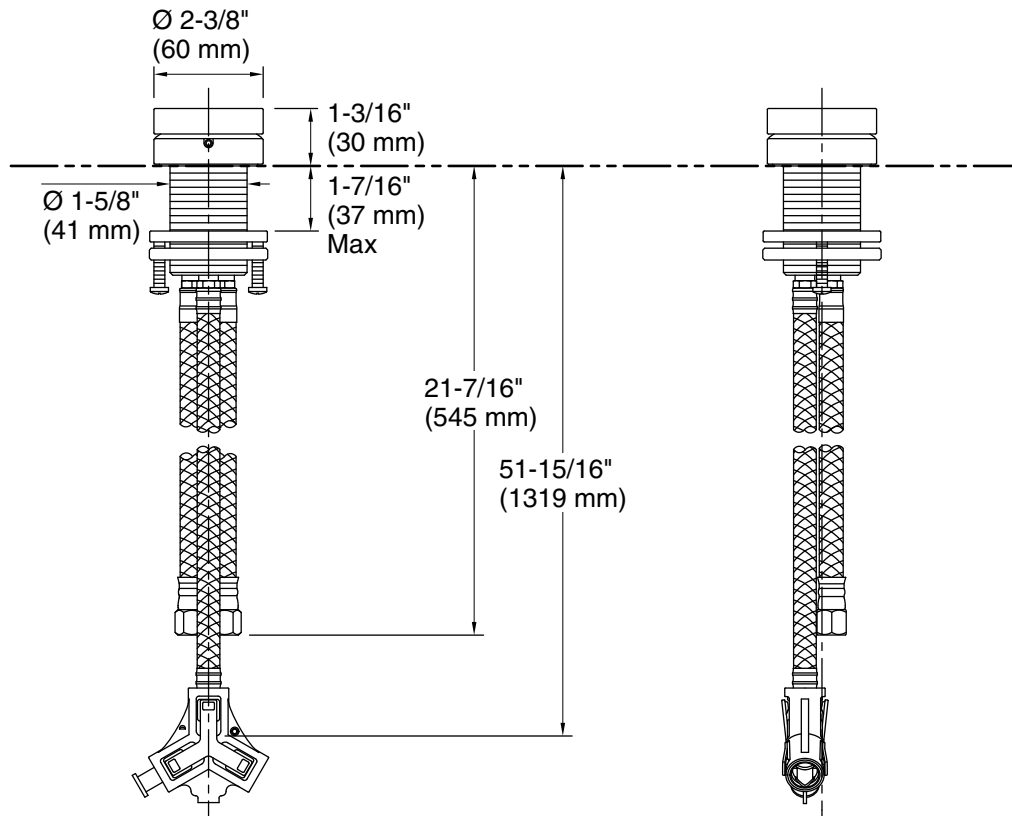

### Technical Information

All product dimensions are nominal.

Drain included: No

### Handshower:

Rated maximum flow: 0 gal/min (0 l/min)

### Notes

Install this product according to the installation instructions.

ADA compliant for handles only.

ADA, OBC, CSA B651 compliant when installed to the specific requirements of these regulations.