

Features

- 6 5/16" spout reach
- 1.2 gpm (4.5 lpm) maximum flow rate at 60 psi (4.14 bar)
- Laminar flow
- Includes metal touch-activated drain with 1-1/4" tailpiece
- Coordinate with your choice of Components bathroom sink faucet handles for a personalized design
- This product can help a building earn Water Efficiency points in LEED® Green Building Rating System

Material

- Premium metal construction for durability and reliability
- KOHLER® finishes resist corrosion and tarnishing

Installation

- Widespread or remote valve

Required Products/Accessories

K-77974-4 Lever bathroom sink faucet handles

or

K-77974-8 Oyl bathroom sink faucet handles

or

K-77974-9 Industrial bathroom sink faucet handles

or

K-77963-8A Rocker bathroom sink faucet handle

Recommended Products/Accessories

K-23726 Drain treatment

K-23723 Faucet cleaner

K-78372 18" Towel Bar

K-78373 24" Towel Bar

K-78375 24" Double Towel Bar

K-78377 Hand Towel Arm

K-78378 Robe Hook

K-78379 Double Towel Arm

K-78382 Pivoting toilet paper holder

K-78383 Vertical toilet paper holder

K-78384 Covered double toilet paper holder



Codes/Standards

ASME A112.18.1/CSA B125.1

NSF/ANSI/CAN 61

NSF/ANSI/CAN 372

All applicable US Federal and State material regulations

DOE - Energy Policy Act 1992

EPA WaterSense®

California Energy Commission (CEC)









IAPMO Certification

KOHLER® Faucet Lifetime Limited Warranty

See website for detailed warranty information.

Available Colors/Finishes

Color tiles intended for reference only.

Color	Code	Description
	CP	Polished Chrome
	SN	Vibrant® Polished Nickel
	AF	Vibrant® French Gold
	BN	Vibrant® Brushed Nickel
	BV	Vibrant® Brushed Bronze
	BL	Matte Black
	2MB	Vibrant® Brushed Moderne Brass
	TT	Vibrant Titanium

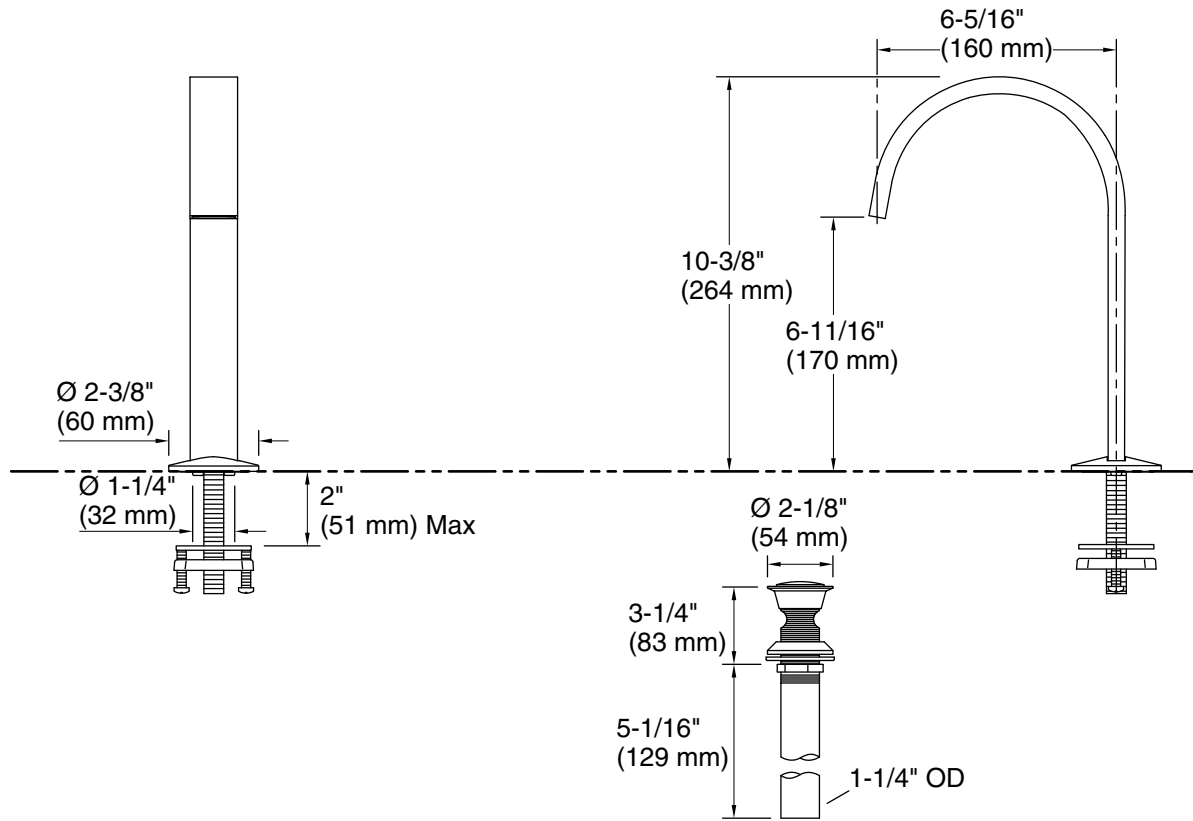

Technical Information

All product dimensions are nominal.

Faucet:

Flow rate: 1.2 gal/min (4.5 l/min)

Drain included: Yes

Spout:

Spout reach: $6\text{-}5/16"$ (160 mm)

Handshower:

Rated maximum flow: 0 gal/min (0 l/min)

Notes

Install this product according to the installation instructions.