

Features

- For baths 15" – 21" (381 – 533 mm) deep from center of bath overflow outlet to center of bath drain outlet
- 30" (762 mm) length external cable
- Flexible overflow joint conforms to various bath angles
- Rotary or push handle controls and pop-up drain stopper (sold separately)
- No internal linkages, reducing the potential for clogging
- Includes tee, drain ell, and overflow ell with attached 1-1/2" OD pipe
- Flexible overflow neck fits various bath angles for easy installation

Material

- Solid-brass construction for durability and reliability
- 17-gauge brass drain pipe

Installation

- Above- or through-the-floor
- Can be installed and tested without required trim kit

Required Products/Accessories

- [K-T37391](#) Rotary-turn bath drain trim
- or [K-T37392](#) Rotary-turn bath drain trim
- or [K-T37393](#) Traditional rotary-turn bath drain trim
- or [K-T37395](#) Bath drain trim
- or [K-T37396](#) Traditional push-button bath drain trim

Recommended Products/Accessories

- K-23726 Drain treatment
- K-23723 Faucet cleaner



Codes/Standards

ASME A112.18.2/CSA B125.2
IAPMO Certification

KOHLER® One-Year Limited Warranty

See website for detailed warranty information.

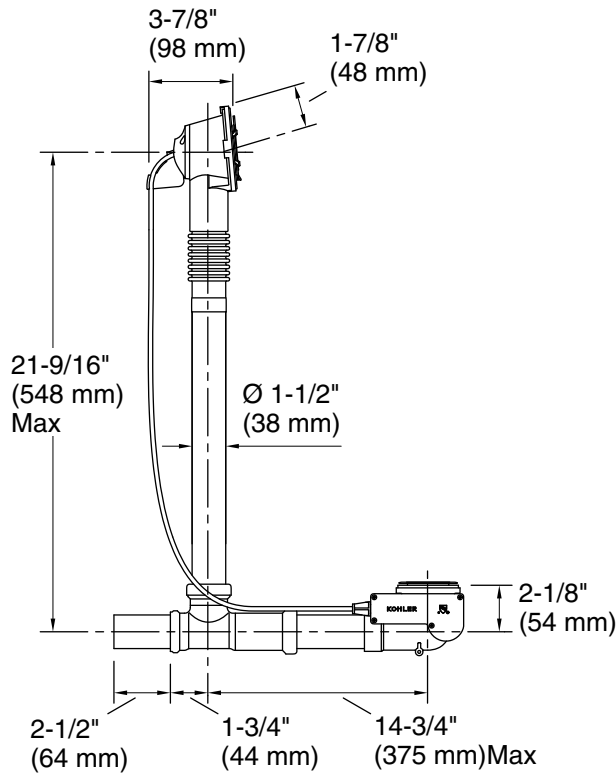

Above-the-Floor

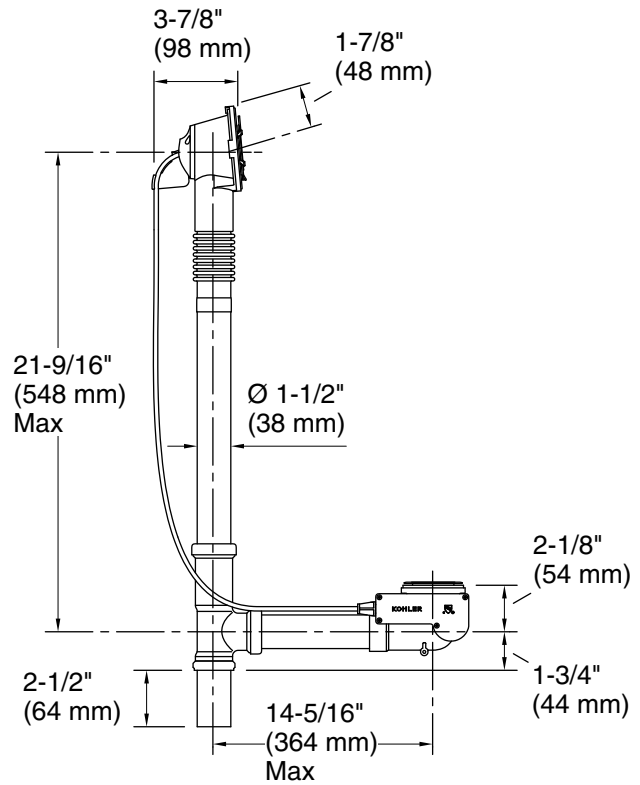

Through-the-Floor

Technical Information

All product dimensions are nominal.

Material: Brass

Height: 21-5/8" (549 mm)

Notes

Install this product according to the installation instructions.