

Features

- 1/2" NPT connections
- Available 27- or 54-nozzle configurations
- 2.0 gpm (7.6 lpm) maximum flow rate at 80 psi (5.5 bar)

Recommended Products/Accessories

K-23723 Faucet cleaner



Codes/Standards







ASME A112.18.1/CSA B125.1
DOE - Energy Policy Act 1992
IAPMO Certification

KOHLER[®] Faucet Lifetime Limited Warranty

See website for detailed warranty information.

Available Colors/Finishes

Color tiles intended for reference only.

Color	Code	Description
	CP	Polished Chrome
	SN	Vibrant [®] Polished Nickel
	AF	Vibrant [®] French Gold
	BN	Vibrant [®] Brushed Nickel
	BV	Vibrant [®] Brushed Bronze
	BL	Matte Black
	2MB	Vibrant [®] Brushed Moderne Brass
	TT	Vibrant Titanium

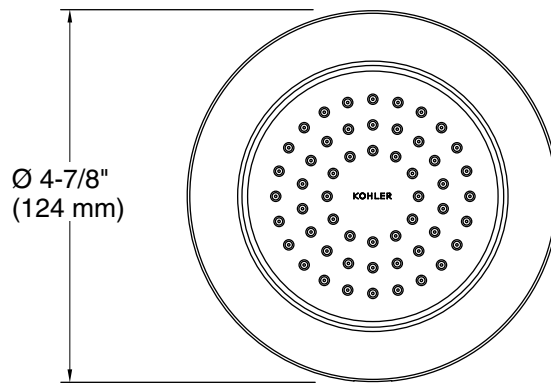
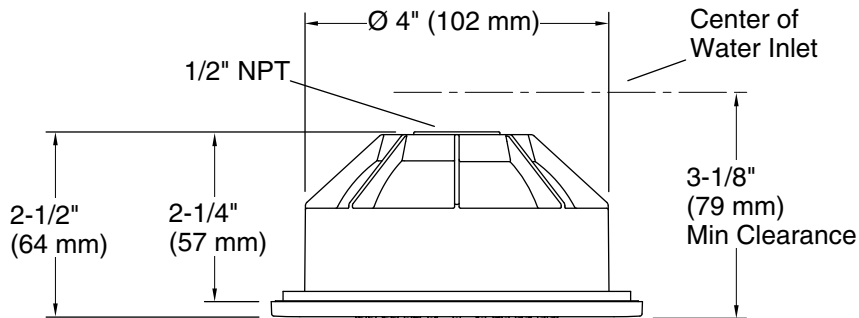

Technical Information

All product dimensions are nominal.

Handshower:

Rated maximum flow: 0 gal/min (0 l/min)

Notes

Install this product according to the installation instructions.