

Features

- Brass construction and valve bodies
- Durable Polished Chrome plate finish
- Quarter-turn washerless ceramic disc valves
- Vandal-resistant aerator
- Vandalproof ADA-compliant wristblade handles with red and blue indexing
- 8-3/16" (208 mm) swing spout
- Less drain
- 1.5 gpm (5.7 lpm) maximum flow rate at 60 psi (4.14 bar)
- Complies with the Safe Drinking Water Act (SDWA)

Installation

- For 8" (203 mm) centers

Recommended Products/Accessories

K-23723 Faucet cleaner



ADA

CSA B651

Codes/Standards

ASME A112.18.1/CSA B125.1

NSF/ANSI/CAN 61

NSF/ANSI/CAN 372

All applicable US Federal and State material regulations

DOE - Energy Policy Act 1992

California Energy Commission (CEC)

ADA

ICC/ANSI A117.1

CSA B651

IAPMO Certification

KOHLER[®] One-Year Limited Warranty

See website for detailed warranty information.

Available Colors/Finishes

Color tiles intended for reference only.

Color	Code	Description
-------	------	-------------



CP	Polished Chrome
----	-----------------

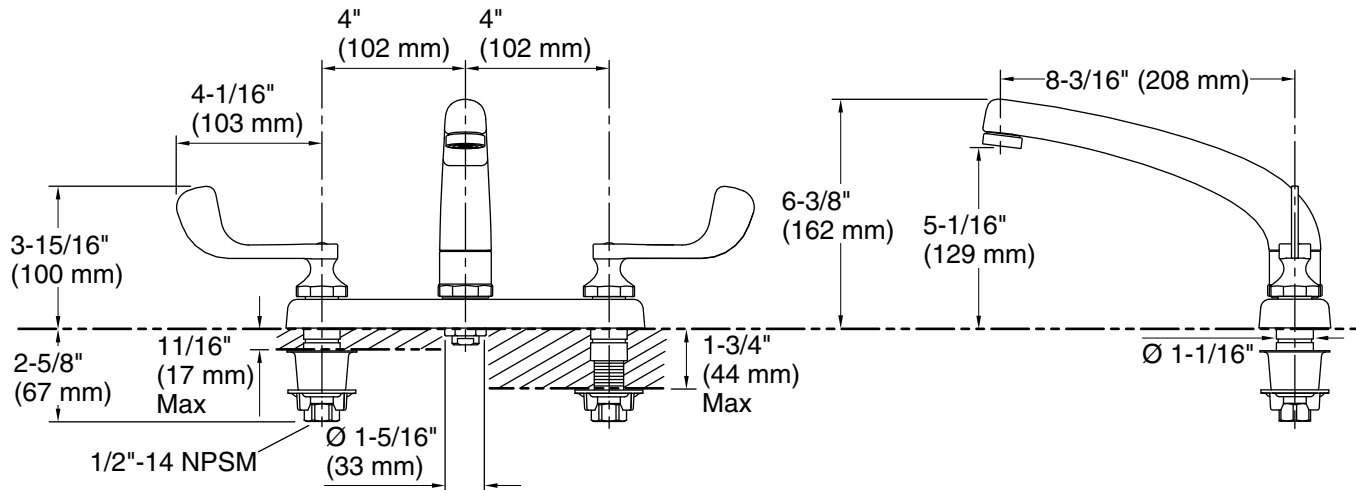

Technical Information

All product dimensions are nominal.

Faucet:

Flow rate: 1.5 gal/min (5.7 l/min)

Drain included: No

Spout:

Spout reach: 8-3/16" (208 mm)

Handshower:

Rated maximum flow: 0 gal/min (0 l/min)

Notes

Install this product according to the installation guide.

ADA compliant for faucet handles only

ADA, CSA B651 compliant when installed to the specific requirements of these regulations.