

Features

- 36" minimum base cabinet width
- Large/medium bowls
- Versatile design allows large bowl to be installed on the right or left
- Large bowl depth: 9-1/2" (241 mm); small bowl depth: 7-1/2" (191 mm)
- Slim divider creates more space while allowing you to completely submerge pots and pans
- Offset drain in larger bowl increases workspace in the sink
- Includes K-5655 sink rack
- Includes cutout templates and installation clips
- Matte finish offers rich, dimensional color

Material

- KOHLER Neoroc® composite is durable and built to withstand day-to-day cleaning tasks
- Solid color throughout the sink
- Heat-resistant up to 750°F
- Scratch-, stain-, chip-, and thermal-shock-resistant

Installation

- Undermount
- Easy to install in a one-person, single-day project

Recommended Products/Accessories

- K-5198 Sink Rack
- K-8801 Sink drain and strainer with tailpiece
- K-8799 Sink drain and strainer basket
- K-23726 Drain treatment
- K-23730 Neoroc® cleaner

Optional Products/Accessories

- K-11352 Disposal Flange with Stopper
- K-9000 P-Trap

Included Components

- K-5655 Sink Rack



Codes/Standards







CSA B45.5/IAPMO Z124
IAPMO Certification

KOHLER® Neoroc® Sinks Lifetime Limited Warranty

See website for detailed warranty information.

Available Colors/Finishes

Color tiles intended for reference only.

Color	Code	Description
	CM6	Matte White
	CM7	Matte Graphite
	CM1	Matte Black
	CM2	Matte Brown
	CM3	Matte Taupe
	CM4	Matte Grey

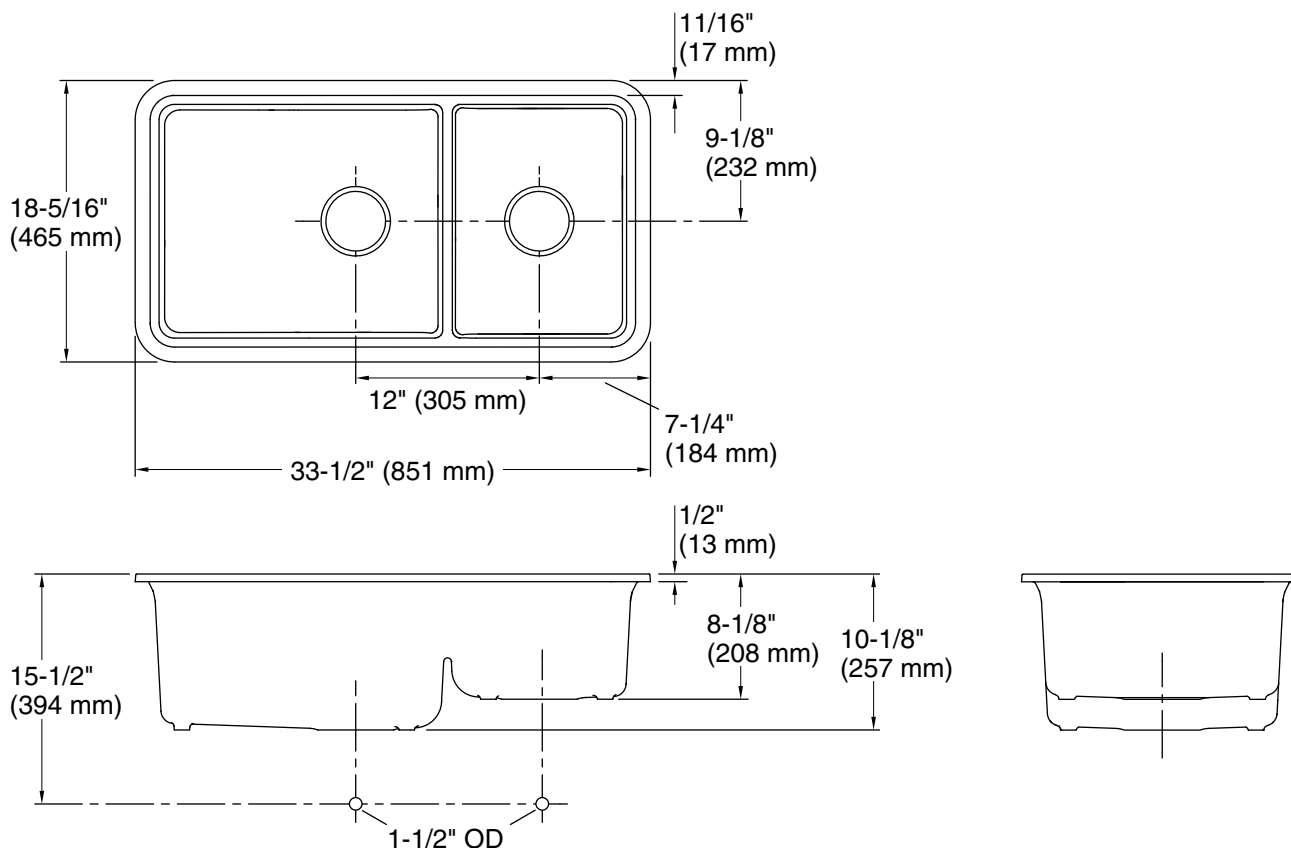

Technical Information

All product dimensions are nominal.

Basin configuration: Large Bowl on Left

Min. base cabinet width: 36" (914 mm)

Bowl area (Double Equal Basins):
 Length: 18-7/16" (468 mm)
 Width: 15-3/16" (386 mm)
 Bowl depth: 9-1/2" (241 mm)
 Water depth: 9-1/2" (241 mm)

Bowl area (Double Equal Basins):
 Length: 11-5/16" (288 mm)
 Width: 15-3/16" (386 mm)
 Bowl depth: 7-1/2" (191 mm)
 Water depth: 7-1/2" (191 mm)

Drain hole: 3-7/8" (98 mm)

Template: 1256394-7, required, included

Notes

Install this product according to the installation instructions.