



Memoirs®

66-1/4" x 36-1/2" freestanding bath
K-8333

Features

- Freestanding design creates a striking focal point in your bathing area
- 17-7/8" (454 mm) soaking depth
- Integral lumbar support
- Slotted overflow allows for deep soaking
- Center toe-tap drain with KOHLER Lithocast® cover
- Coordinates with other products in the Memoirs collection

Material

- KOHLER Lithocast® Gloss cast resin

Installation

- Freestanding

Recommended Products/Accessories

K-23726 Drain treatment

K-23732 Tub & shower cleaner



Codes/Standards

CSA B45.5/IAPMO Z124

IAPMO Certification

KOHLER® Plastic Baths and Shower Bases Lifetime Limited Warranty

See website for detailed warranty information.

Available Colors/Finishes

Color tiles intended for reference only.

Color	Code	Description
-------	------	-------------

	0	White
---	---	-------

1-800-4KOHLER (1-800-456-4537)

Kohler Co. reserves the right to make revisions without notice to product specifications.

For the most current Specification Sheet, go to www.kohler.com USA or www.kohler.ca Canada

7-13-2024 20:04 - US

THE BOLD LOOK
OF **KOHLER**®

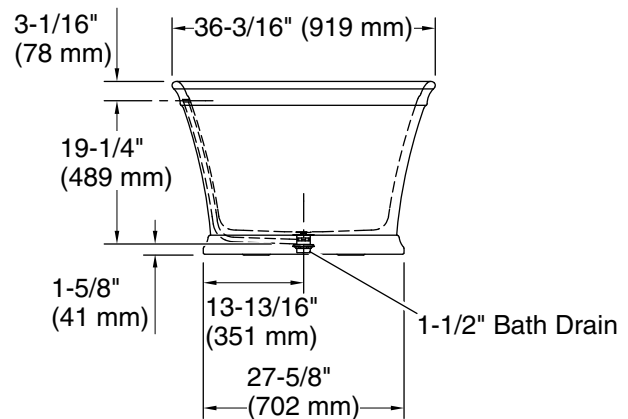
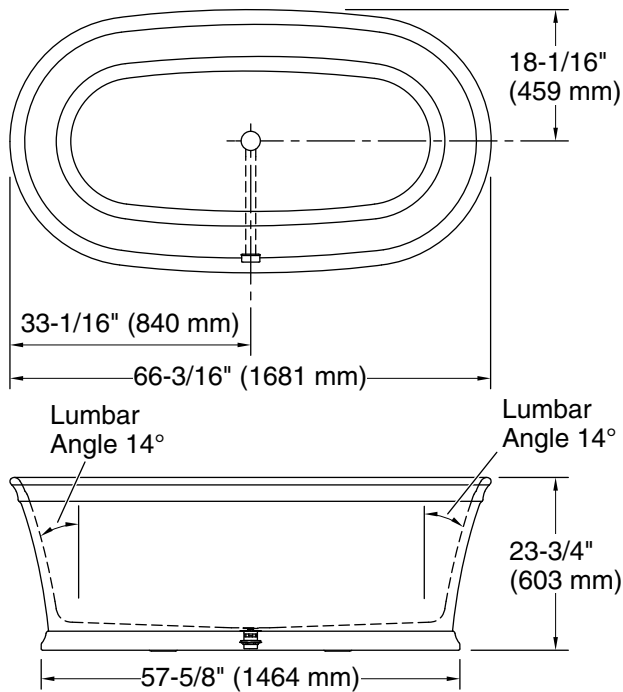

Technical Information

All product dimensions are nominal.

Drain location:	Center
Basin area, bottom:	53-7/16" x 23-5/16" (1358 mm x 592 mm)
Basin area, top:	63-9/16" x 33-9/16" (1614 mm x 852 mm)
Weight:	262 lbs (118.8 kg)
Minimum floor load:	112.2 lbs/ft ² (547.8 kg/m ²)
Water depth:	17-7/8" (454 mm)
Water capacity:	98.74 gal (373.8 L)
Template:	Footprint, 1314994, not required, not included

Notes

Measure your actual product for rough-in details.

Install this product according to the installation instructions.

The hot water supply should be 70% of the capacity of the bath or greater. Installations will vary.

Allow for 3" (76 mm) diameter of clearance around the drain pipe on finished floor material to prevent drain body interference during installation.