

Features

- Low-threshold design for easy entry and exit
- Molded-in textured floor
- Water containment bead incorporated into threshold design provides an optimum barrier, preventing water from escaping from shower space
- Single threshold for alcove installation
- Coordinates with Choreograph® shower walls and other KOHLER® collections

Material

- Acrylic

Installation

- Right drain

Recommended Products/Accessories

- K-9132 Shower Drain
- K-23726 Drain treatment
- K-23732 Tub & shower cleaner







Codes/Standards

- CSA B45.5/IAPMO Z124
- ASTM E162
- ASTM E662
- IAPMO Certification

KOHLER® Plastic Baths and Receptors Lifetime Limited Warranty
See website for detailed warranty information.

Available Colors/Finishes

Color tiles intended for reference only.

Color	Code	Description
	0	White
	96	Biscuit
	NY	Dune
	95	Ice™ Grey

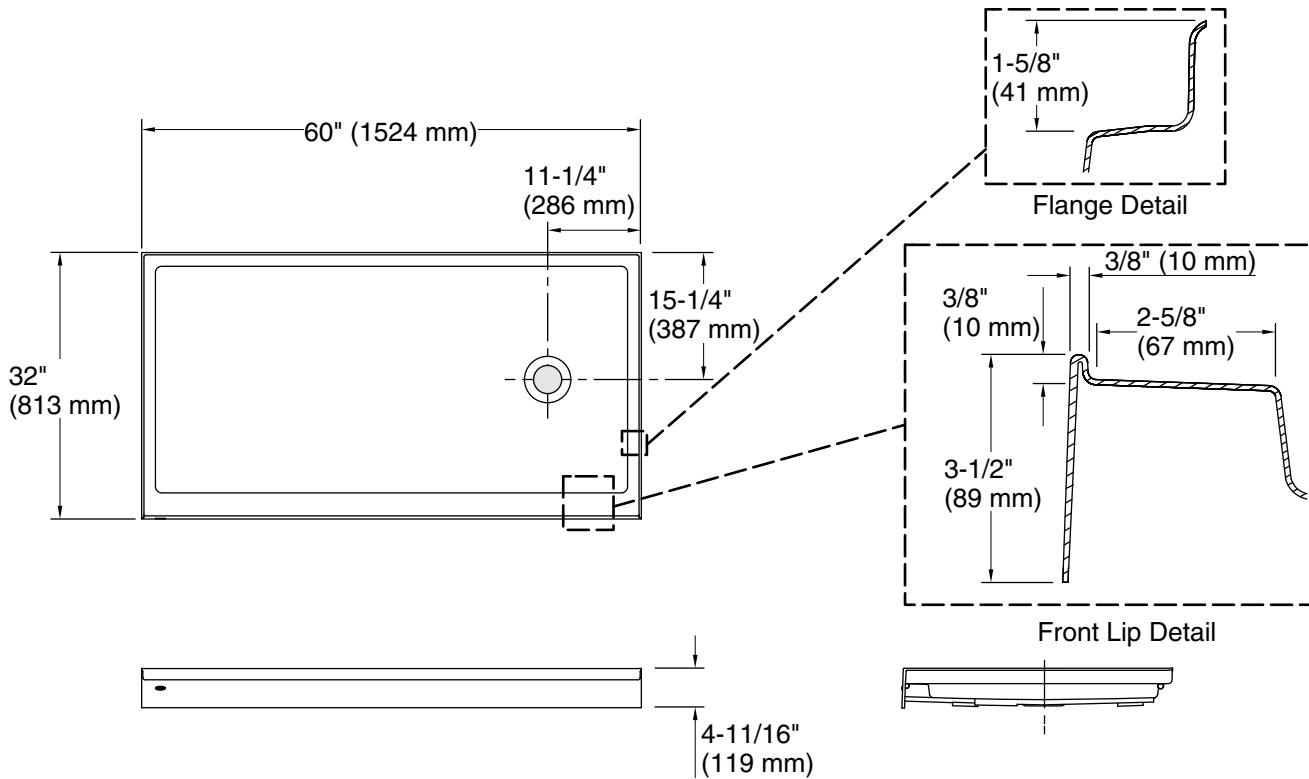

Technical Information

All product dimensions are nominal.

Drain location:	Right
Weight:	62 lbs (28.1 kg)
Minimum flat for door:	2-5/8" (67 mm)

Notes

Measure your actual product for rough-in details.

Install this product according to the installation instructions.

Subfloor must be within 1/2" (13 mm) of level.

This receptor has a front lip. This should be taken into account when installing a shower door.