

Features

- 6 hydromassage jets can be individually adjusted for water flow and direction
- Variable-speed pump for adjusting hydromassage intensity
- 10 backjets target the lower back and shoulders to relieve tension and encourage deep breathing
- Adjustable neckjet pillow with 2 jets provides a stimulating, stress-relieving neck massage
- Built-in heater
- Electronic keypad
- Remote control
- Safeguard® slip-resistant surface provides excellent traction underfoot
- Drilled for grab bars (required); sold separately

Material

- KOHLER® enameled cast iron

Hydrotherapy

- Whirlpool
- Backjets
- Neckjets

Installation

- Reversible drain
- Drop-in
- Requires cable pop-up bath drain and bath drain trim (sold separately)

Required Products/Accessories

K-9653 Grab bars for whirlpool baths with Spa/Massage package

or

K-23857 Bath drain trim

or

K-78440 33" cable pop-up bath drain

Recommended Products/Accessories

K-1601 Bath/whirlpool footstop, removable
K-9696 Whirlpool 6-Jet Trim Kit
K-587 Under-Mount Installation Kit
K-1179 Vinyl Tiling-in Bead
K-23726 Drain treatment
K-23725 Cast iron cleaner
K-31796 Above-the-floor bath drain kit
K-31798 Bath drain kit



Codes/Standards







ASME A112.19.1/CSA B45.2
ASME A112.19.7/CSA B45.10
ASTM F462
UL 1795
CSA C22.2 No. 218.2
IAPMO Certification
cUL Listed
UL Listed

KOHLER® Enameled Cast Iron Bath and Shower Base Lifetime Limited Warranty KOHLER® Hydrotherapy Components Five-Year Limited Warranty

See website for detailed warranty information.

Available Colors/Finishes

Color tiles intended for reference only.

Color	Code	Description
	0	White
	96	Biscuit
	NY	Dune
	95	Ice™ Grey
	58	Thunder™ Grey
	7	Black Black™

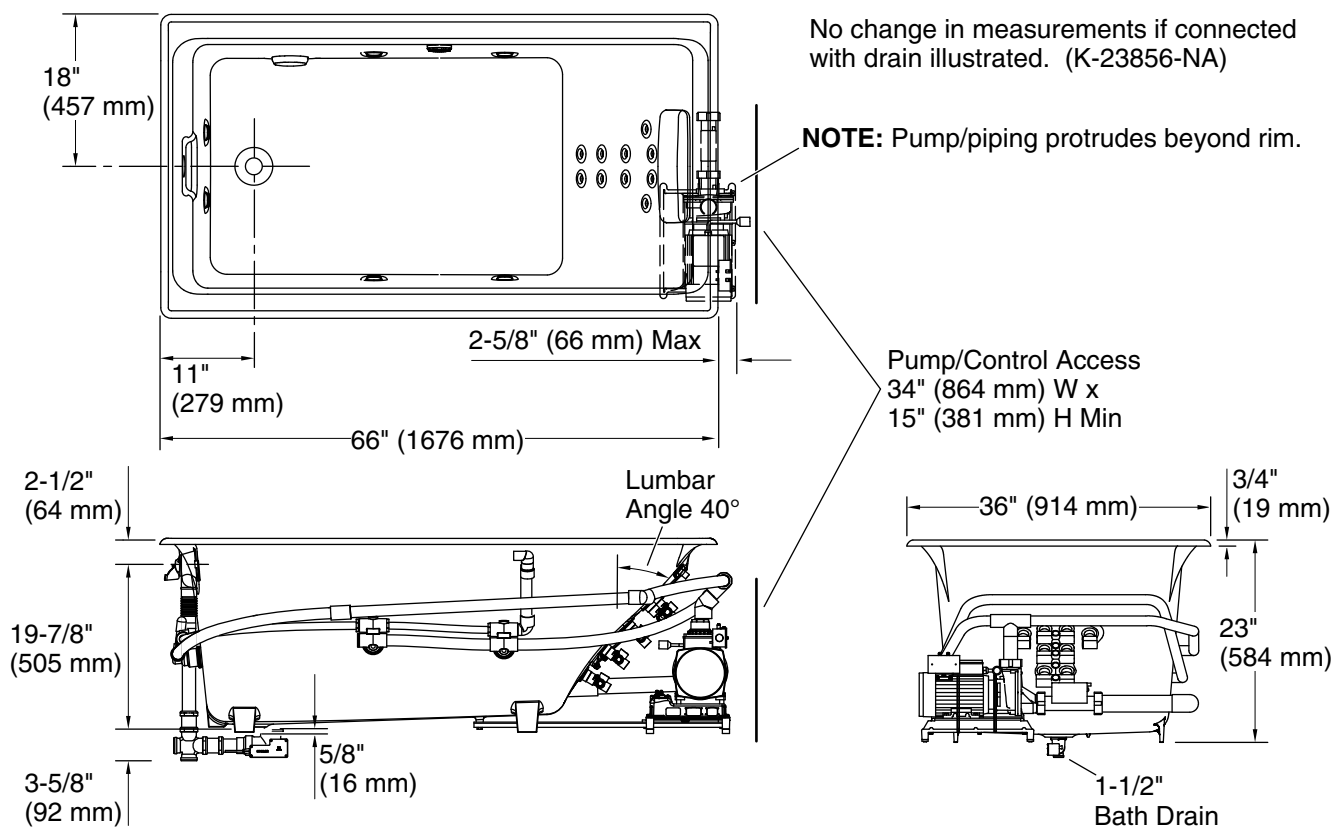

Required Electrical Service

One dedicated circuit required, protected with Class A Ground-Fault Circuit-Interrupter (GFCI). Outside North America, this device may be known as a Residual Current Device (RCD).

Pump, Heater: 240 V, 20 A, 50/60 Hz

Technical Information

All product dimensions are nominal.

Drain location: Reversible
 Basin area, bottom: 45" x 25" (1143 mm x 635 mm)
 Basin area, top: 58" x 29" (1473 mm x 737 mm)
 Weight: 510 lbs (231.3 kg)
 Minimum floor load: 81 lbs/ft² (395.5 kg/m²)
 Water depth: 18" (457 mm)
 Water capacity: 96 gal (363.4 L)
 Cutout: Drop-in, 65-1/2" x 35-1/2" (1664 mm x 902 mm)

Electrical component rating: Pump: 240 V, 50/60 Hz
 Heater: 240 V, 6 A, 1500 W

Pump speed: Variable

Minimum flat for: 1-15/16" (50 mm)

1-800-4KOHLER (1-800-456-4537)

Kohler Co. reserves the right to make revisions without notice to product specifications.

For the most current Specification Sheet, go to www.kohler.com USA or www.kohler.ca Canada

7-13-2024 20:04 - US

Notes

Measure your actual product for rough-in details.

Install this product according to the installation instructions.

The hot water supply should be 70% of the capacity of the bath or greater. Installations will vary.

Kit is required for under-mount installations (sold separately).

Cast iron whirlpools are extremely heavy, making some drop-in installations difficult.

Splitting the deck/surround is recommended if installing into a deck.