

## Features

- 30" (762 mm) minimum base cabinet width
- Single bowl
- 9" (229 mm) depth provides generous workspace
- Five oversized faucet holes
- Bowl slopes toward drain to minimize water pooling
- Offset drain increases workspace in the sink and storage space underneath
- Includes K-6239 colander with integral cutting board and K-9137 bottom sink rack

## Material

- KOHLER® enameled cast iron

## Installation

- Undermount

## Recommended Products/Accessories

- K-8801 Sink drain and strainer with tailpiece
- K-8799 Sink drain and strainer basket
- K-23726 Drain treatment
- K-23725 Cast iron cleaner
- 1411886 Undermount sink kit 23"

## Optional Products/Accessories

- K-11352 Disposal Flange with Stopper
- K-9000 P-Trap

## Included Components

- K-6239 Colander with Cutting Board
- K-9137 Sink Rack



## Codes/Standards









ASME A112.19.1/CSA B45.2  
IAPMO Certification

## KOHLER® Enameled Cast Iron Kitchen and Bathroom Sink Lifetime Limited Warranty

See website for detailed warranty information.

## Available Colors/Finishes

*Color tiles intended for reference only.*

Color	Code	Description
	0	White
	FF	Sea Salt™
	96	Biscuit
	NY	Dune
	95	Ice™ Grey
	58	Thunder™ Grey
	7	Black Black™
	TRF	Truffle

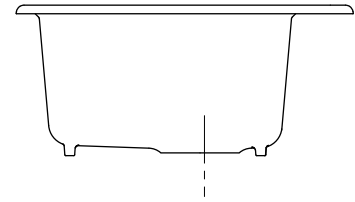
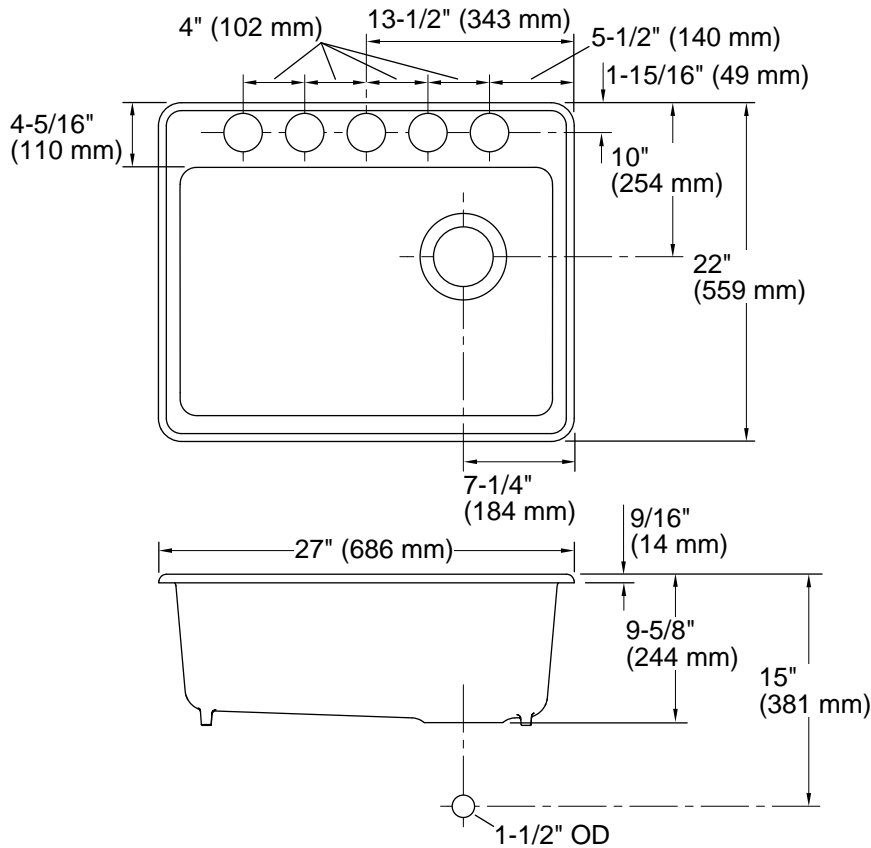

## Technical Information

All product dimensions are nominal.

Basin configuration: Single Bowl

Center(s): 8" (203 mm)

Min. base cabinet width: 30" (762 mm)

Bowl area (Basin #1):  
Length: 24-1/4" (616 mm)  
Width: 15-13/16" (402 mm)  
Bowl depth: 9" (229 mm)  
Water depth: 9" (229 mm)

Number of deck holes: 5

Drain hole: 3-7/8" (98 mm)

Template: 1244382-7, required, included

## Notes

Install this product according to the installation instructions.