

Features

- 36" minimum base cabinet width
- Single bowl
- 5-1/4" depth
- Bowl slopes toward drain to minimize water pooling
- Offset drain increases workspace in the sink and storage space underneath
- Three faucet holes and one accessory hole to the right

Material

- KOHLER® enameled cast iron

Installation

- Top-mount

Recommended Products/Accessories

- K-6237 Left-Bowl Sink Rack
- K-6255 Right-Bowl Sink Rack
- K-8801 Sink drain and strainer with tailpiece
- K-8799 Sink drain and strainer basket
- K-23726 Drain treatment
- K-23725 Cast iron cleaner
- K-35000 Three-piece workstation sink accessory set
- K-35001 Maple wood cutting board
- K-35002 Ice bucket holder
- K-35003 Workstation sink cover
- K-35005 Marble serving tray
- K-35487 Three-piece ice bucket set
- K-35484 Three-piece workstation sink prep bowl set

Optional Products/Accessories

- K-11352 Disposal Flange with Stopper
- K-9000 P-Trap



ADA

Codes/Standards



ASME A112.19.1/CSA B45.2
ADA
ICC/ANSI A117.1
IAPMO Certification

KOHLER® Enameled Cast Iron Kitchen and Bathroom Sink Lifetime Limited Warranty

See website for detailed warranty information.

Available Colors/Finishes

Color tiles intended for reference only.

| Color | Code | Description |
|---|------|--------------|
|  | 0 | White |
|  | 96 | Biscuit |
|  | 7 | Black Black™ |

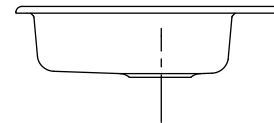
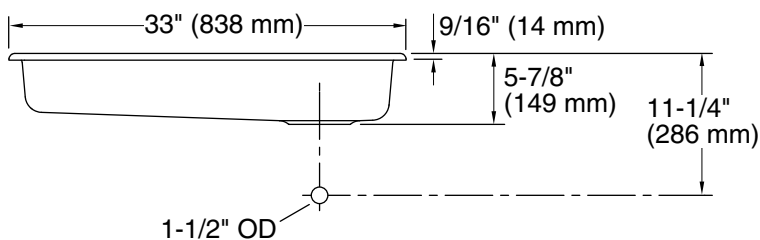
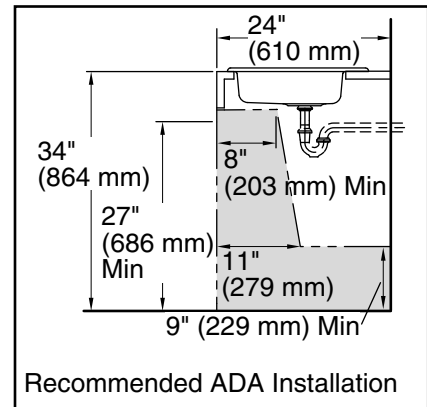
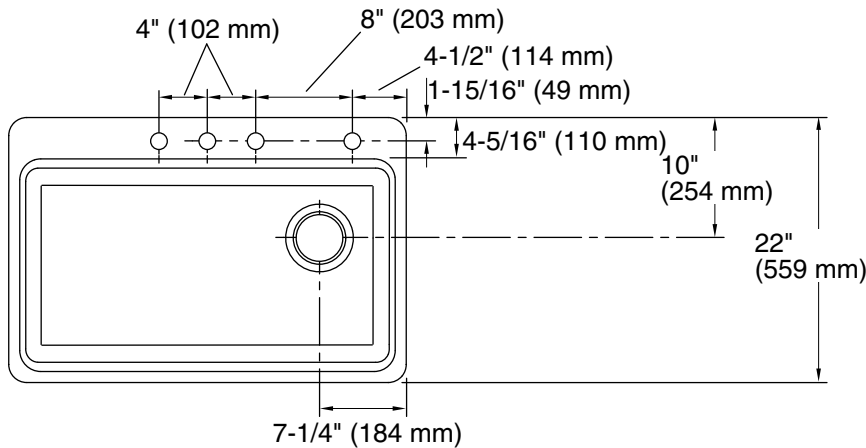

Technical Information

All product dimensions are nominal.

Basin configuration: Single Bowl

Center(s): 4

Min. base cabinet width: 33" (838 mm)

Basin area (Basin #1):
Length: 30-1/4" (769 mm)
Width: 15-13/16" (402 mm)
Bowl depth: 5-1/4" (133 mm)
Water depth: 5-1/4" (133 mm)

Number of deck holes: 4

Faucet hole spacing: 4" (102 mm)

Template: 1166727-7, required, included

Notes

Install this product according to the installation instructions.

ADA compliant when installed to the specific requirements of these regulations.