

Features

- Low-threshold design for easy entry and exit
- Covered drain with removable cover
- Single threshold for alcove installation
- Coordinates with other products in the Archer collection

Material

- Acrylic

Installation

- Center drain

Recommended Products/Accessories

- K-9132 Shower Drain
- K-23726 Drain treatment
- K-23732 Tub & shower cleaner



Codes/Standards







- CSA B45.5/IAPMO Z124
- ASTM E162
- ASTM E662
- IAPMO Certification

KOHLER® Plastic Baths and Receptors Lifetime Limited Warranty

See website for detailed warranty information.

Available Colors/Finishes

Color tiles intended for reference only.

Color	Code	Description
	0	White
	96	Biscuit
	NY	Dune
	95	Ice™ Grey
	58	Thunder™ Grey
	7	Black Black™

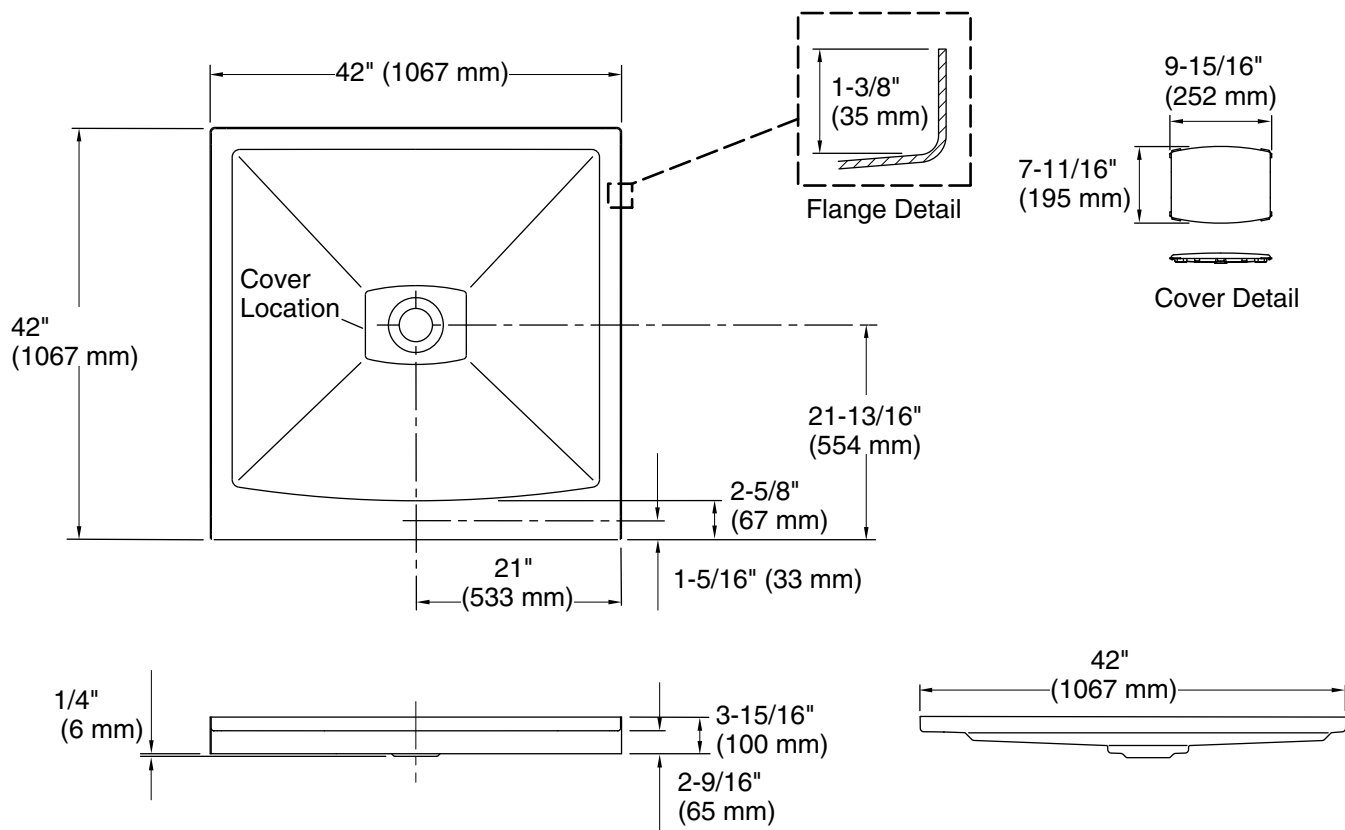

Technical Information

All product dimensions are nominal.

Drain location:	Center
Weight:	44 lbs (20 kg)
Minimum floor load:	20 lbs/ft ² (97.6 kg/m ²)
Minimum flat for door:	2-5/8" (66 mm)

Notes

- Measure your actual product for rough-in details.
- Install this product according to the installation instructions.
- Shimming may be required to level the fixture.
- Shimming may be required between the stud frame and the fixture.
- Stud opening tolerance is + 1/4" (6 mm), - 0" (0 mm).