

NOTE: BEFORE CUTTING COUNTERTOP ALLOW FOR HANDLE CLEARANCE.
注意: 切割台面时, 请预留龙头把手的操作距离。

FINISHED WALL / BACK SPLASH
完工墙面/防溅挡板

CENTERLINE OF FITTING
安装中线

夹子位置
CLIP LOCATIONS

KOHLER

K-97011T
乔司 CHALICE

台下盆
UNDERCOUNTER LAVATORY
切割图/安装说明书
CUT-OUT TEMPLATE / INSTALLATION INSTRUCTIONS

安装之前

- 有关安装专业性, 故盥洗台下脸盆必须由受过训练及有经验的技师进行安装。
- 切勿在本品上使用胶黏剂或有黏性的密封胶。
- 检查出水及供水管道, 如有需要便更换。
- 安装之前先开启新脸盆的包装, 检查有无损坏后放回纸箱中以免损坏, 到准备安装时才取用。
- 遵守当地所有给排水及建筑规定。
- 科勒洗脸盆是根据美国标准制造的, 与美式洗脸盆配件相配。其它洗脸盆配件可能与之不相配。

所需工具及物料
(不随货供应)

- 密封胶
 - 炭笔
 - 卷尺
 - 尖刀或剪刀
 - 匙孔线锯或手提电锯
 - 钻头直径1/2英寸或更大的电钻
 - 防护眼镜
 - 锤子
 - 抹布或抹布纸
- 注意: 若盥洗台的物料并非水或木质合成品, 则您可能需要在安装脸盆时使用其他更专门的工具。

BEFORE YOU BEGIN

- Due to the nature of the installation, undercounter lavatories should be installed by trained and experienced installers.
- Do not use adhesives or adhesive sealants with this product.
- Inspect the waste and supply tubing, replace if necessary.
- Prior to installation, unpack the new lavatory and inspect it for damage. Return the lavatory to its protective carton until you are ready to install it.
- Observe all local plumbing and building codes.
- Kohler lavatory is made according to American National Standard that it can match the American lavatory fittings. Any other lavatory fittings may not fit for Kohler lavatory.

TOOLS AND MATERIALS
(Not Supplied)

- Sealant
 - Pencil
 - Tape measure
 - Sharp knife or scissors
 - Keyhole or saber saw
 - Drill (1/2" dia. drill bit or larger)
 - Safety glasses
 - Hammer
 - Rags or paper toweling
- NOTE:** You may require different, more specialized tools to install this lavatory to countertop materials other than wood or wood composites.

尺寸图

Reference Value
参考值

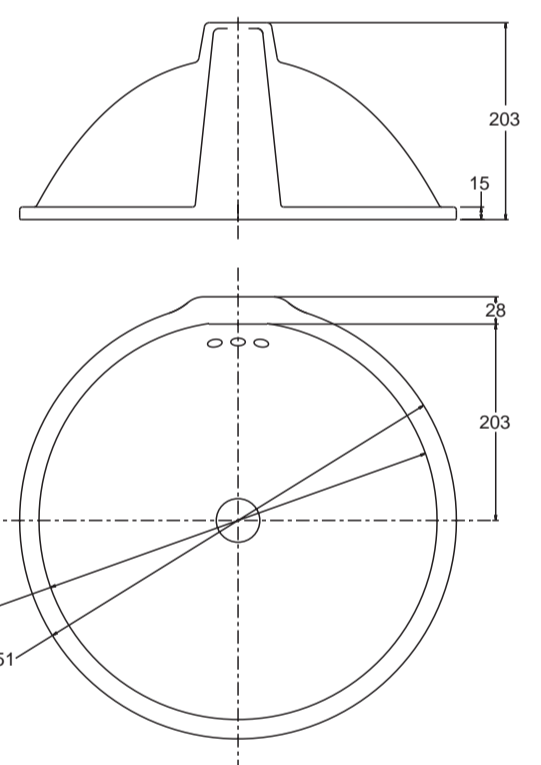

ROUGHING-IN

Unit: mm
单位: 毫米

Outer 外尺寸	Length 长	Width 宽	Height 高	Depth 盆深
451	451	457	203	157
Inner 内尺寸	406	406		

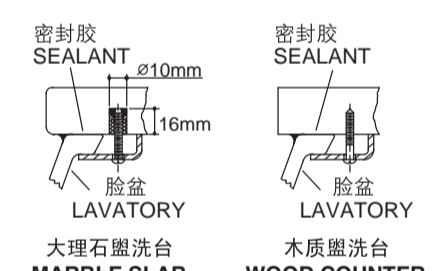

Note: waterproof unprotected overhang area on the underside of wood counter.
注: 木质盥洗台面板下突出部份须作防水处理。

安装脸盆

- 检查准备装上脸盆的位置, 是否与后挡板、水龙头、脸盆及柜子保持足够的距离。
- 剪出模板。
- 将模板小心放置于台上, 并在台面上按照模板画出其边缘轮廓导线。
- 在盥洗台上标出水龙头孔位的中心线。
- 在切线内则钻一个1/2英寸的导孔。
- 用手提电锯或匙孔线锯切开洗台。

木制盥洗台

- 按照模板所示的位置, 在台面上标出及预先钻妥木螺钉的孔位。
- 其他外露的木表面需保持防水。

大理石盥洗台

- 大理石盥洗台倒过来放在泡沫垫上以保护其表面, 按照模板所示的位置钻妥各个3/8英寸(10mm)直径及5/8英寸(16mm)深的孔位。
- 利用安装工具及锤子来固定预埋螺母。

所有安装

- 如还未安装盥洗台, 请在这时装上。
- 按照龙头安装说明引钻龙头孔。
- 按照制造商的说明书, 在盥洗台上装水龙头。
- 按照制造商的说明书, 在脸盆下装上排水管。

注意: 请勿在本品上使用胶黏剂或有黏性的密封胶。在与盥洗台接触的脸盆边缘, 如珠串胶滴上优质密封胶。

注意: 随附的螺钉只适用于最少1英寸(25mm)厚的盥洗台, 而较薄的盥洗台则要用其他合适的预埋螺母及紧固件。

- 在木、木质合成物及大理石的盥洗台上安装脸盆时, 可使用随附的夹具及螺钉, 其他物料制造的盥洗台, 则请参考盥洗台制造商的说明书上的建议, 使用适当的配件。
- 在上紧夹具前, 先将脸盆平整地放在盥洗台切口下, 然后小心将脸盆拉起直至合度才可上夹具, 切勿上得太紧。
- 立即擦去多余的密封胶。
- 最后将所有水管及水龙头与脸盆连接妥当, 确保安装符合水管及水龙头的一切有关的安装说明书。

- 使用非腐蚀性清洁剂进行清洁。

用户须知

(护理和清洁)

- 为保持脸盆光洁如新, 须确保每次使用后彻底冲洗干净, 切勿使用腐蚀性的清洁剂, 以免刮花及破坏脸盆的表面。要清除顽固污垢, 油漆或柏油, 可使用松油或油漆稀释剂。
- 不要在0°C以下的水环境中使用。
- 请勿使用钢丝球等硬质材料擦洗产品表面, 特别是产品商标处。

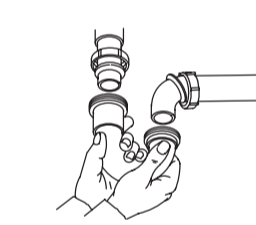
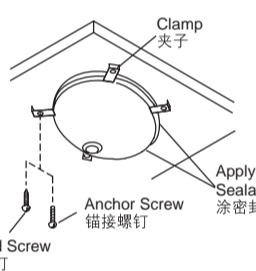
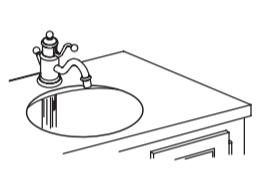
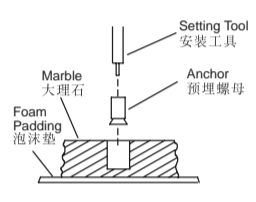
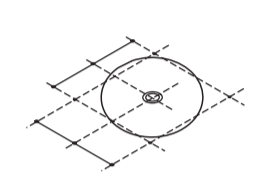
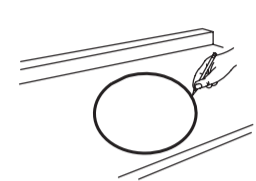

INSTALL THE LAVATORY

- Check the desired lavatory location for clearance between the backsplash, faucet, fixture, and cabinet.
- Cut out the template.
- Carefully position and trace the template on the countertop as directed on the template.
- Mark the faucet hole centerline on the countertop.
- Drill a 1/2" pilot hole on the inside of the cut line.
- Cut out the countertop opening with a saber or keyhole saw.

FOR WOOD COUNTERTOPS

- Mark and pre-drill the wood screw holes at the locations shown on the template.
- Waterproof any exposed areas of wood.

FOR MARBLE COUNTERTOPS

- Position the countertop upside down on foam padding to protect the surface. Mark and drill 3/8" (10mm) holes 5/8" (16mm) deep at the locations shown on the template.
- Use a setting tool and hammer to secure the anchors.

FOR ALL INSTALLATIONS

- If the countertop has not been installed, install it at this time.
- Drill the faucet holes according to the faucet installation instructions.
- Install the faucet to the countertop according to the manufacturer's instructions.
- Install the drain to the lavatory according to the manufacturer's instructions.

NOTE: Do not use adhesives or adhesive sealants. Apply a continuous bead of quality sealant to the lavatory rim where it will contact the countertop.

NOTE: The screws provided should be used on countertops with a minimum 1" (25mm) thickness. For thinner countertops, use appropriate anchors and fasteners.

- For wood, wood composite, and marble countertops, install the lavatory to the countertop with the clamps and screws provided. For other countertop materials, refer to the countertop manufacturer's instructions for recommended fasteners.
- Position the lavatory squarely under the cutout before tightening the clamps. Draw the lavatory rim up to the countertop until it is snug. **Do not overtighten.**
- Immediately wipe away any excess sealant.
- Make the final drain and faucet connection to complete the lavatory installation. Be sure to follow all instructions packed with the drain and faucet.
- Clean up with a **non-abrasive** cleaner.

IMPORTANT CONSUMER

INFORMATION (CARE AND CLEANING)

- To keep your lavatory looking new, make sure you rinse it out thoroughly after each use. **DO NOT USE ABRASIVES** on this product, as they will scratch and ruin the surface. Stubborn stains, paint, or tar can be removed with turpentine or paint thinner.
- Do not use the product in the water below 0°C.
- Please do not use hard materials (like scouring pad) to clean product surface, especially the product logo.

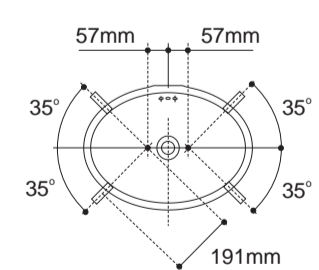

夹子位置
CLIP LOCATIONS

脸盆边缘
RIM OF LAVATORY

沿此线切割
CUT ALONG THIS LINE

1236153-T01-A

© 版权为科勒中国有限公司所有, 2014
© Copyright Kohler China Ltd., 2014