

Note: Make sure enough faucet installation clearance.  
注意: 预留足够的龙头安装空间。

当按实际大小绘制切割图时, 请确定脸盆水平及垂直方向的大小跟切割图上所标注的尺寸是一致的。  
WHEN PLOTTING TEMPLATE FULL SIZE: Make sure horizontal and vertical dimensions match the dimensions labeled on the template.

FINISHED WALL / BACK SPLASH  
完工墙面/防溅挡板

**K-2764T-1/K-98420T-TG/K-98420T-TS**  
**皓玥 HAOYUE**  
釉面陶瓷时尚脸盆  
VITREOUS CHINA VESSEL  
切割图/安装说明书  
CUT-OUT TEMPLATE / INSTALLATION INSTRUCTIONS

**安装之前**

- 留意当地所有给排水及建筑规定。
- 检查排水管及供水管。如有需要请更换。
- 安装之前, 先开启新脸盆的包装, 并小心检验新的脸盆是否有损坏, 再将新的脸盆放回包装盒内, 到安装时才取出。
- 若为更换新脸盆, 须确保现有的柜台孔口与新脸盆的切割位相同或者较后者小。
- 请使用同时印在此说明书上的安装模板。切勿在本品上使用环氧树脂胶或水泥等硬化后体积变大的密封材料。
- 如果有可能的话, 在安装脸盆之前组装脸盆上的水龙头和排水管。
- 科勒洗脸盆是根据美国标准制造的, 与美式洗脸盆配件相配。其它洗脸盆配件可能与之不相配。

**建议工具及材料**

- 安装模板(已提供)
- 护眼镜
- 软性铅笔
- 卷尺
- 涂油灰刀
- 匙孔线锯或者手提电锯
- 密封胶
- 剪刀
- 切管刀
- 钻头直径为13毫米或更大的钻
- 活动扳钳
- 喉管扳钳
- 钢锯

**BEFORE YOU BEGIN**

- Observe all local plumbing and building codes.
- Inspect the drainage and supply tubing; Replace if necessary.
- Prior to installation, unpack the new lavatory and carefully inspect it for damage. Return the lavatory to its protective carton until you are ready to install it.
- For replacement installations, make sure the existing cutout is the same or smaller size as the new lavatory.
- Use the template supplied with the lavatory.
- Do not use epoxy resin adhesive or sealing materials that will expand after concreting, such as cement.
- If possible, assemble the faucet and drain to the lavatory before installing the lavatory.
- Kohler lavatory is made according to American National Standard that it can match the American lavatory fittings. Any other lavatory fittings may not fit for Kohler lavatory.

**RECOMMENDED TOOLS AND MATERIALS**

- Template(supplied)
- Safety Glasses
- Pencil
- Tape Measure
- Putty Knife
- Keyhole Saw or Saber Saw
- Sealant
- Scissors
- Pipe Wrench
- Drill With 1/2"(13mm) Or Larger Drill Bit
- Adjustable Wrench
- Tubing Cutter
- Hacksaw

**ROUGHING-IN**

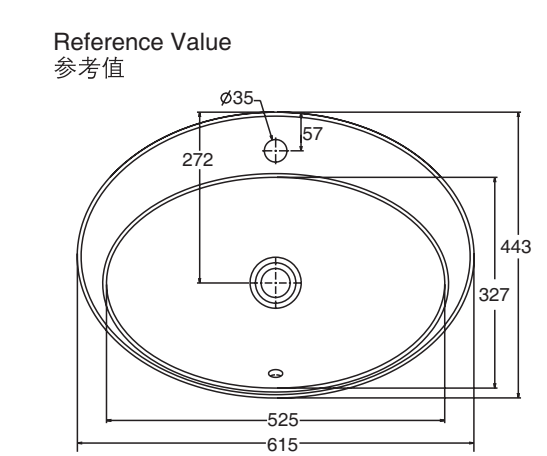

科勒公司保留随时变更图中标示尺寸的权利, 无需另行通知。  
Kohler reserves the right to change marked dimensions without prior notice.

**尺寸图**

Unit: mm  
单位: 毫米

	Length 长	Width 宽	Height 高	Depth 盆深
Outer 外径	615	443	198	
Inner 内径	525	327		148

**拆除旧脸盆**

- 关掉水龙头的供水源。
- 打开水龙头阀门, 然后拆下供水管。
- 拆下排水组件存水弯。
- 移走旧脸盆。

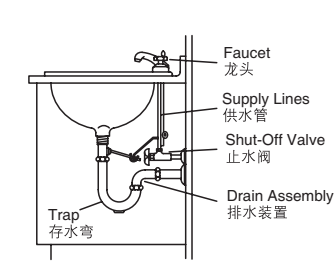

**REMOVE EXISTING LAVATORY**

- Turn off the water supply to the faucet.
- Open the faucet valves, then disconnect the supply lines.
- Disconnect the drain assembly and remove the trap.
- Remove the existing lavatory.

**安装新脸盆**

- 将切割模板沿切割线切出。
- 将切割模板放在盥洗台上, 确保脸盆、水龙头和防溅挡板之间有足够距离。检查柜台下的储物柜有足够的空间。
- 用炭笔沿切割模板在盥洗台面上划线。
- 检查脸盆、水龙头、防溅挡板和储物柜间的距离, 如有需要, 可调整切割模板的位置。

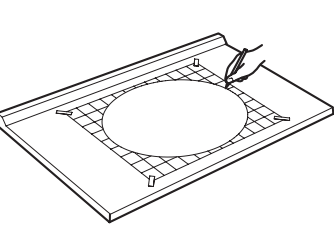

**INSTALL NEW LAVATORY**

- Cut the template on the cutout line.
- Position the template on the countertop to ensure clearance between the lavatory, faucet, and backsplash. Verify cabinet clearance beneath the countertop.
- Trace the template on the countertop with a pencil.
- Check the clearance between the lavatory, faucet, backsplash, and cabinet. Readjust the template.

沿此线切割  
CUT ALONG THIS LINE

脸盆边缘  
RIM OF LAVATORY

- 用一个13毫米的钻头, 在切割图的内侧钻出一个导孔。
- 沿着自切割模板勾画出来的炭笔划线的内侧, 切开台面。

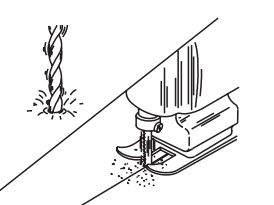

- Drill a 1/2"(13mm) hole on the inside of the outline.
- Cut the opening in the countertop along the inside edge of the pencil line.

- 小心: 提防身体受伤或者损坏产品。因大型脸盆相当重, 需要找人帮助您一起搬动及安放。

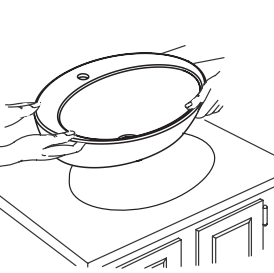

- CAUTION: Risk of personal injury or product damage. Large lavatories are very heavy. Get help lifting the lavatory into place.
- Temporarily position the lavatory in the opening, and adjust to fit.
- Trace a pencil line around the outside edge of the lavatory.
- Remove the lavatory.

- 暂将脸盆放入台面开口, 校正位置。
- 用炭笔沿脸盆外缘在盥洗台上划线。
- 然后将脸盆移开。

如果水龙头和排水管还未安装, 请在此时安装。请按制造商的说明书进行操作。

IF THE FAUCET AND DRAIN ARE NOT INSTALLED, INSTALL THEM AT THIS TIME. PLEASE FOLLOW THE MANUFACTURER'S INSTRUCTIONS.

- 沿炭笔划线内倒涂密封胶。
- 用涂油灰刀将其抹匀。

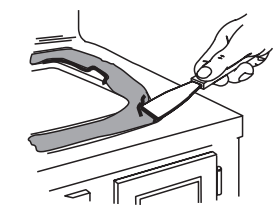

- Apply sealant to the inside of the pencil line.
- Spread the sealant evenly with a putty knife.

- 注意: 只能使用柔软的防水密封胶。
- 切勿使用环氧树脂胶或水泥等硬化后体积变大的密封材料。科勒对所有因此而引起的陶瓷破裂恕不负责。

- NOTE: Please use soft and water-proof sealant.
- Do not use epoxy resin adhesive or sealing materials that will expand after concreting, such as cement. Otherwise, Kohler will not be responsible for any product damage caused by such material.

- 小心: 提防身体受伤或者损坏产品。因大型脸盆相当重, 需要找人帮助您一起搬动及安放。

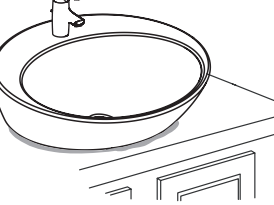

- CAUTION: Risk of personal injury or product damage. Large lavatories are very heavy. Get help lifting the lavatory into place.
- Carefully position the lavatory in the cutout, and press down firmly.

- 立即擦去多余的密封胶, 如脸盆外缘与台面之间有缝隙, 即用胶堵密。
- 检查脸盆的位置正确。
- 最少待三十分钟, 让密封胶干透后, 方可继续进行安装。

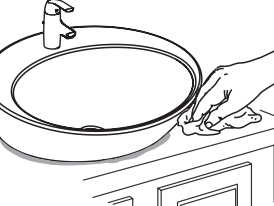

- Immediately wipe away any excess sealant, and fill any voids as needed.
- Verify that the lavatory has not moved out of position.
- Allow the sealant to cure for at least 30 minutes before proceeding.

**连接供水**

- 连接排水装置。
- 连接水龙头供水管并且完成水龙头安装。一定要遵循水龙头包装上的所有使用说明。

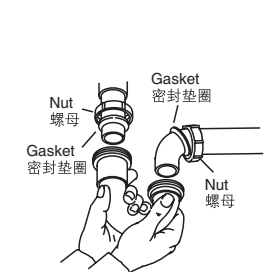

- CONNECT SUPPLIES
- Connect the drain assembly.
- Connect the faucet supply lines and complete the faucet installation. Be sure to follow all instructions packed with the faucet.

**用户须知 (护理和清洁)**

为保持脸盆光洁如新, 须确保每次使用后彻底冲洗干净。切勿使用腐蚀性的清洁剂, 以免刮花及破坏脸盆的表面。要清除顽固污垢, 油漆或粘油, 可使用松油或油漆稀释剂。

**IMPORTANT CONSUMER INFORMATION (CARE AND CLEANING)**

To keep your lavatory looking new, make sure you rinse it out thoroughly after each use. DO NOT USE ABRASIVES on this product, as they will scratch and ruin the surface. Stubborn stains, paint, or tar can be removed with turpentine or paint thinner. Do not use the product in the water below 0°C.

- 不要在0°C以下的水环境中使用。
- 警告: 请勿使用钢丝球等硬质材料擦洗产品表面, 特别是产品商标处。

- CAUTION: Please do not use hard materials (like scouring pad) to clean product surface, especially the product logo.

1198881-T01-A

© 版权为科勒中国有限公司所有, 2012  
© Copyright Kohler China Ltd., 2012