



Stoneridge™ | K-CA33783-10L

80-5/16" H frameless sliding shower door with 3/8" -thick Crystal Clear glass

Features

- Frameless design emphasizes glass and creates a sleek, minimalist look
- Innovative roller design with stainless steel bearings simplifies installation and provides out-of-plumb adjustability while glass is installed
- Contemporary towel bar and knob combination offers storage on the outside of the door without encroaching on the bathing space
- Cushioned center guide provides smooth, quiet sliding action
- Tempered glass ensures enhanced safety and durability
- Stays Closed bumpers press against glass to keep door firmly closed, providing excellent water containment
- CleanCoat®+ glass coating creates a hydrophobic barrier that repels water, soap scum, and residue, saving time and protecting shower doors 10 times longer than original CleanCoat. (Based on 2021 internal wear/abrasion testing using a microfiber cloth.)
- Smooth, easy-to-clean wall jams



Available Colors/Finishes

Color tiles intended for reference only.

- SHP Bright Polished Silver
- BL Matte Black
- 2MB Vibrant Brushed Moderne Brass
- BNK Anodized Brushed Nickel



1-800-4KOHLER (1-800-456-4537)

Kohler Co. reserves the right to make revisions without notice to product specifications.

For the most current specification sheet, go to www.kohler.com USA or www.kohler.ca Canada.

5-13-2026 15:56 - US-CA

THE BOLD LOOK
OF **KOHLER**

Codes/Standards

ANSI Z97.1 (Tempered Glass)
CAN/CGSB-12.1
CPSC 16CFR 1201

Technical Information

All product dimensions are nominal.

Base-To-Wall Radius - Maximum:	5/16" (8 mm)
Shower Ledge Minimum Flat:	2-1/2" (64 mm)
Shower Wall Minimum Flat:	3-7/16" (87 mm)
Weight:	94 lbs (42.6 kg)

Material

- Frameless, 3/8" (10 mm) thick Crystal Clear tempered glass
 - Anodized aluminum prevents rust and corrosion
-

Warranty

See website for detailed warranty information.

KOHLER® Bath and Shower Doors Commercial One-Year Limited
Warranty



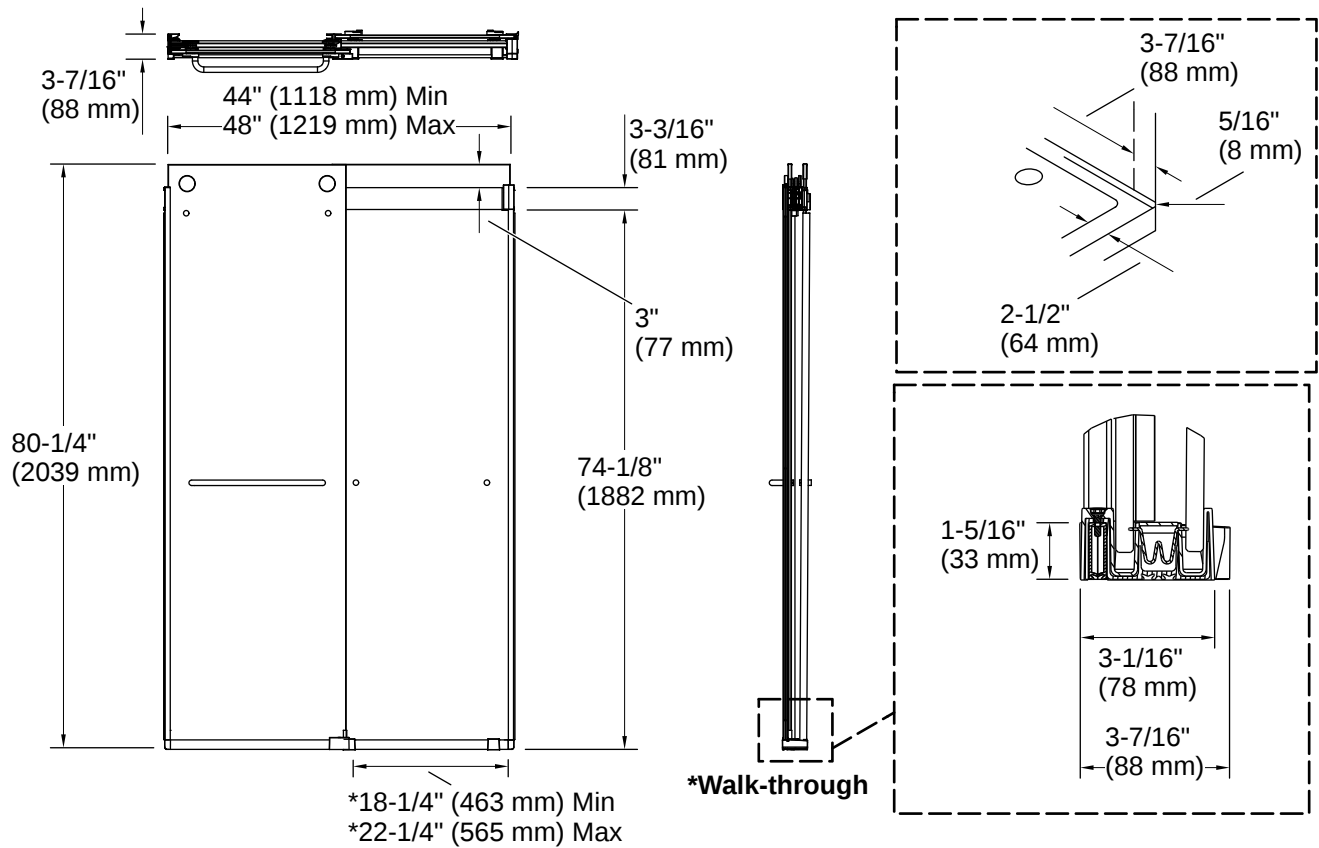

Installation

- Fits opening widths 44" - 48" (1118 -1219 mm)
- 80-5/16" (2040 mm) high, with a lofty 74-1/8" (1883 mm) minimum head clearance
- 4" (102 mm) width adjustment
- Out-of-plumb adjustability simplifies installation
- For residential and hospitality use

Installation Notes

Install this product according to the installation instructions.

The vertical opening should be a minimum of 82-1/4" (2089 mm) to allow for installation clearance.

