

Features

- Lever handle
- 35° spout
- Includes showerhead with arm and flange, nondiverter spout with NPT connection, and faceplate with handle and push-button diverter
- Pressure-balancing diaphragm technology maintains outlet temperature within +/-3°F during water pressure fluctuations
- Coordinates with Purist faucets, accessories, and showering components to complete your bathroom

Material

- Premium material construction for durability and reliability
- KOHLER® finishes resist corrosion and tarnishing

Installation

- Trim only; requires valve to complete installation (sold separately)

Required Products/Accessories

K-11748 Series Rite-Temp® Valves

Recommended Products/Accessories

K-23723 Faucet cleaner

Optional Products/Accessories

88526 Thin Wall Trim Kit

1016154 Rite-Temp® Deep Rough-In



Codes/Standards

ASME A112.18.1/CSA B125.1

DOE - Energy Policy Act 1992









IAPMO Certification

KOHLER® Faucet Lifetime Limited Warranty

See website for detailed warranty information.

Available Colors/Finishes

Color tiles intended for reference only.

Color	Code	Description
	CP	Polished Chrome
	SN	Vibrant® Polished Nickel
	AF	Vibrant® French Gold
	BN	Vibrant® Brushed Nickel
	BV	Vibrant® Brushed Bronze
	BL	Matte Black
	2MB	Vibrant® Brushed Moderne Brass
	TT	Vibrant Titanium

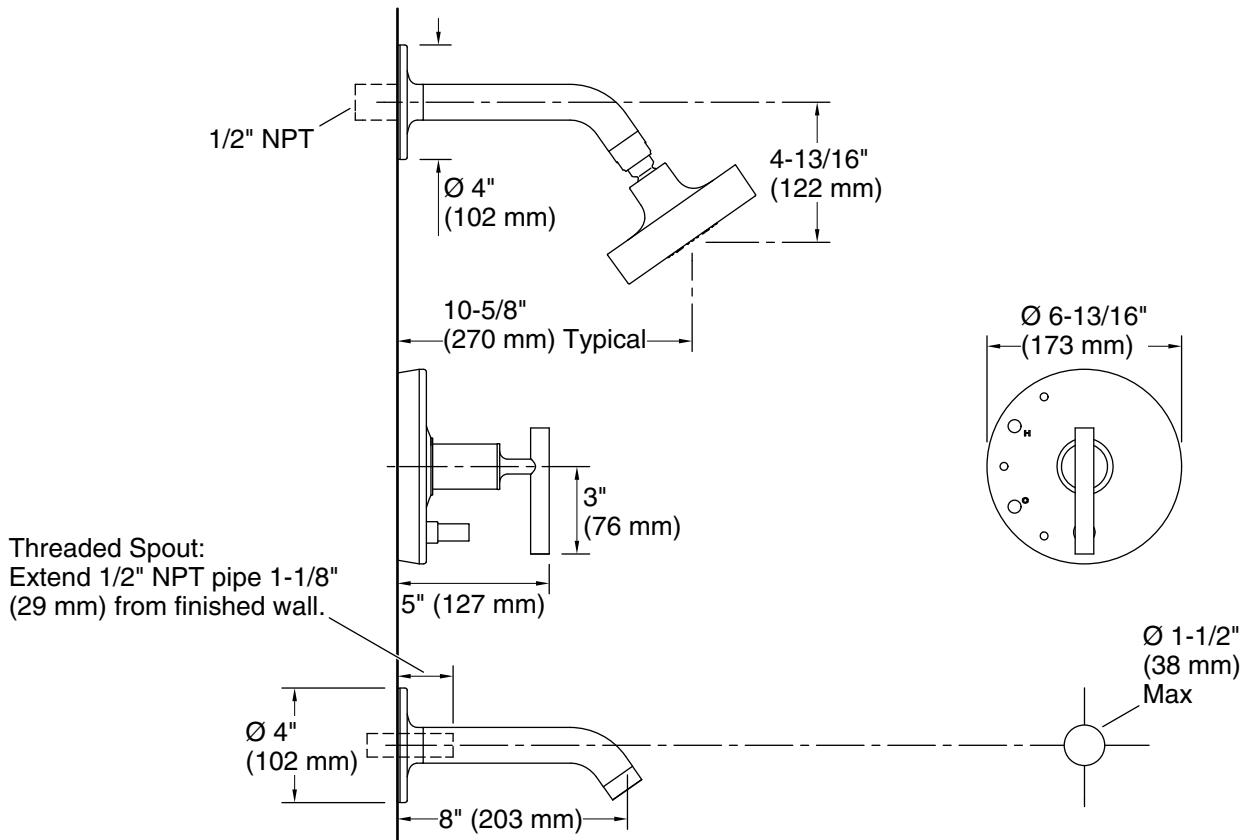

Technical Information

All product dimensions are nominal.

Drain included: No

Spout:

Spout reach: 8-1/16" (205 mm)

Handshower:

Rated maximum flow: 0 gal/min (0 l/min)

Showerhead/Body Spray:

Rated maximum flow: 2.5 gal/min (9.5 l/min)

Notes

Install this product according to the installation guide.

Avoid cross-flow conditions. Do not install shut-off device on either valve outlet.

Cap the shower outlet if deck-mount spout, diverter, or handshower is connected to the spout outlet.

Install straight pipe or tube drop of 7" (178 mm) to 18" (457 mm) with single elbow between valve and wall-mount spout.