

Features

- Includes faceplate and lever handle
- Single lever handle controls flow to outlets
- Lever handle
- When used with K-728 Series MasterShower® diverter valves, handle controls flow to two or three outlets individually or any two outlets at a time
- When used with K-737 Series MasterShower diverter valves, handle controls flow to two or three outlets individually or only one outlet at a time.
- 360° handle rotation with three-outlet operation
- 120° handle rotation with two-outlet operation
- Complements Tempered faucets and accessories

Material

- KOHLER® finishes resist corrosion and tarnishing

Installation

- Trim only; requires valve to complete installation (sold separately)
- Patented K-joint installation technology ensures consistent trim appearance, regardless of variability in valve rough-in

Required Products/Accessories

- K-728-K 3/4" two- or three-way transfer valve
- or
- K-737-K 3/4" Two- or Three-Way Diverter Valve

Recommended Products/Accessories

- K-23723 Faucet cleaner



ADA CSA B651 OBC

Codes/Standards





ASME A112.18.1/CSA B125.1
ADA
ICC/ANSI A117.1
CSA B651
OBC
IAPMO Certification

KOHLER® Faucet Lifetime Limited Warranty

See website for detailed warranty information.

Available Colors/Finishes

Color tiles intended for reference only.

Color	Code	Description
	CP	Polished Chrome
	SN	Vibrant® Polished Nickel
	BN	Vibrant® Brushed Nickel
	BL	Matte Black
	2MB	Vibrant® Brushed Moderne Brass

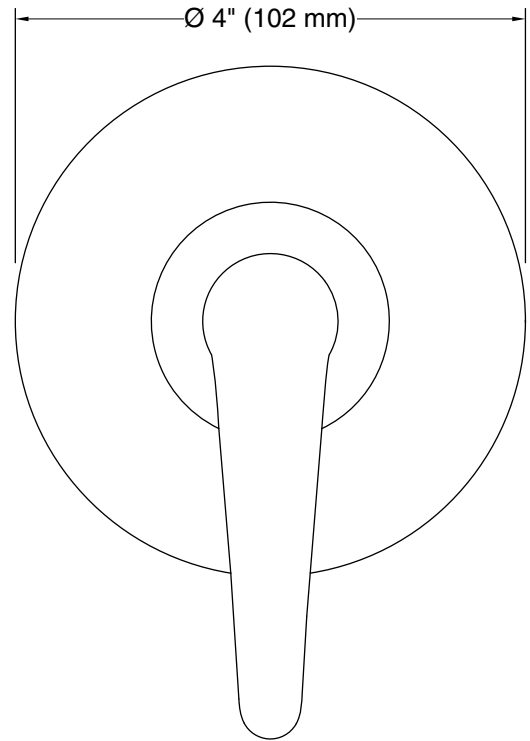
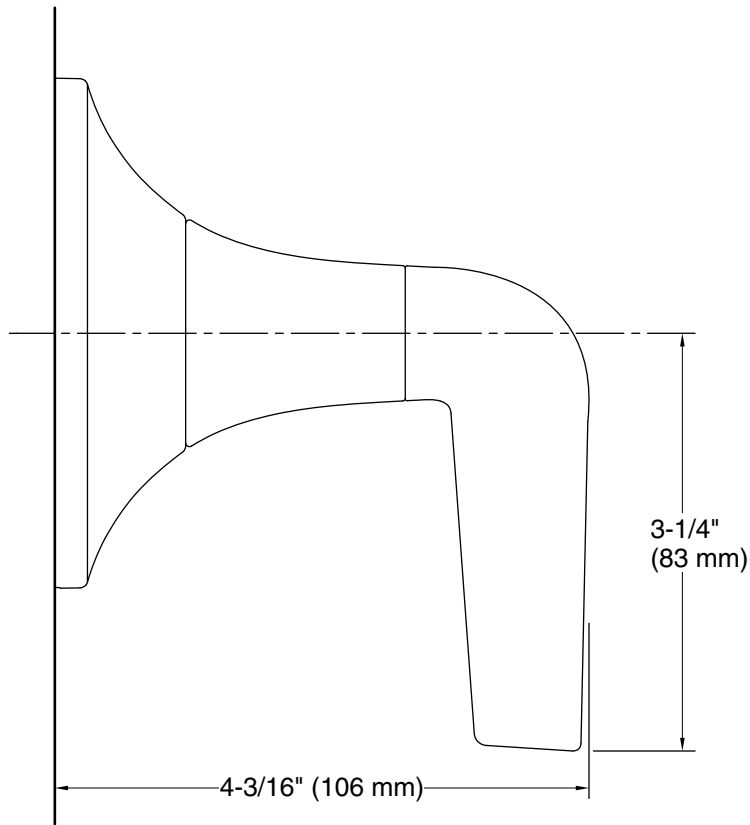

Technical Information

All product dimensions are nominal.

Handshower:

Rated maximum flow: 0 gal/min (0 l/min)

Notes

Install this product according to the installation instructions.

ADA, OBC, CSA B651 compliant when installed to the specific requirements of these regulations.