

### Features

- Single handle controls flow to outlets
- ADA-compliant ergonomic handle
- Coordinates with other products in the Tone collection
- Trim only; requires K-728-K two- or three-way transfer valve, or K-737-K two- or three-way diverter valve (sold separately)

### Material

- Premium material construction with metal handle ensures reliability and durability
- KOHLER® finishes resist corrosion and tarnishing

### Installation

- Patented K-joint installation technology ensures consistent trim appearance, regardless of variability in valve rough-in
- Wall-mount

### Recommended Products/Accessories

K-23723 Faucet cleaner



ADA

CSA B651

OBC

### Codes/Standards

ASME A112.18.1/CSA B125.1

ADA

ICC/ANSI A117.1

CSA B651

OBC







IAPMO Certification

### KOHLER® Faucet Lifetime Limited Warranty

See website for detailed warranty information.

### Available Colors/Finishes

*Color tiles intended for reference only.*

Color	Code	Description
	CP	Polished Chrome
	BN	Vibrant® Brushed Nickel
	BL	Matte Black
	2MB	Vibrant® Brushed Moderne Brass
	CBL	Matte Black with Polished Chrome
	BMB	Matte Black with Moderne Brass

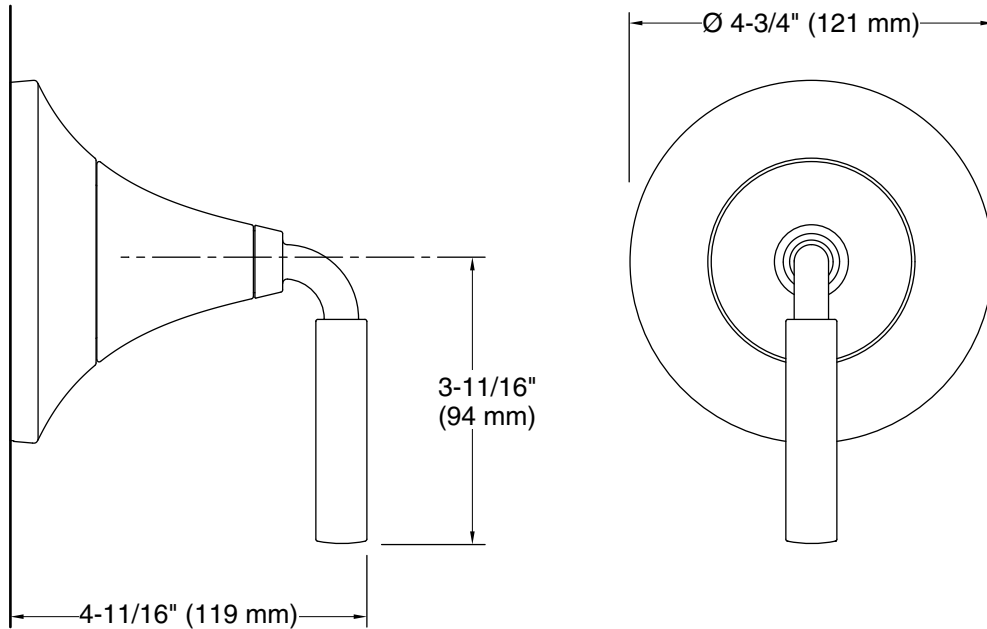

### Technical Information

All product dimensions are nominal.

Drain included: No

### Handshower:

Rated maximum flow: 0 gal/min (0 l/min)

### Notes

ADA, OBC, CSA B651 compliant when installed to the specific requirements of these regulations.