

Features

- Two Lever handles offer separate control of hot and cold water
- 8-9/16" (217 mm) spout reach with slip-fit connection and diverter knob
- Coordinates with other products in the Tone collection
- Trim only, requires valve to complete installation

Material

- Premium metal construction for durability and reliability
- KOHLER® finishes resist corrosion and tarnishing

Installation

- Deck- or bath-mount

Required Products/Accessories

K-438-K 1/2" ceramic high-flow valve system

Recommended Products/Accessories

- K-23723 Faucet cleaner
- K-29478 Deck-mount handshower holder with hose
- K-21335-G Round two-function handshower, 1.75 gpm
- K-27425 18" towel bar
- K-27426 24" towel bar
- K-27427 Robe hook
- K-27428 Towel ring
- K-27429 Pivoting toilet paper holder



Codes/Standards







ASME A112.18.1/CSA B125.1
 ADA
 ICC/ANSI A117.1
 CSA B651
 OBC
 IAPMO Certification

KOHLER® Faucet Lifetime Limited Warranty

See website for detailed warranty information.

Available Colors/Finishes

Color tiles intended for reference only.

Color	Code	Description
	CP	Polished Chrome
	BN	Vibrant® Brushed Nickel
	BL	Matte Black
	2MB	Vibrant® Brushed Moderne Brass
	BMB	Matte Black with Moderne Brass
	CBL	Matte Black with Polished Chrome

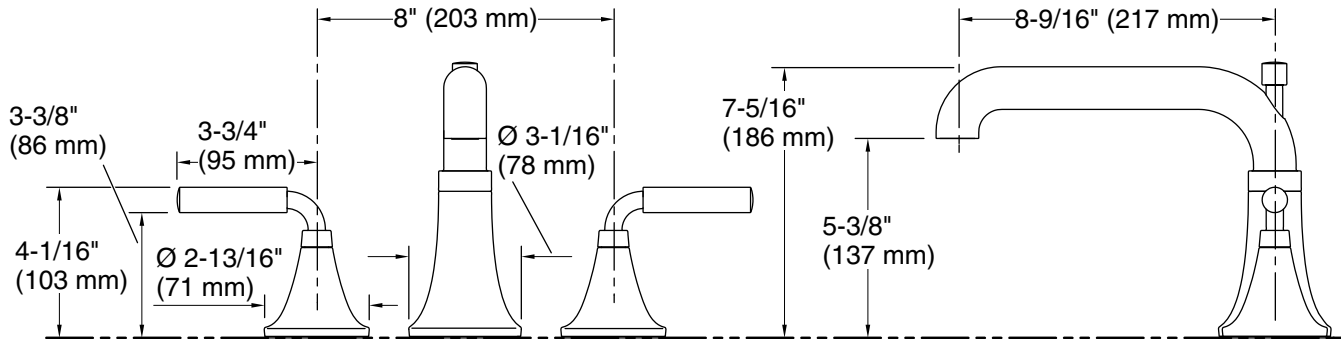

Technical Information

All product dimensions are nominal.

Drain included: No

Spout:

Spout reach: 8-9/16" (217 mm)

Handshower:

Rated maximum flow: 0 gal/min (0 l/min)

Notes

Install this product according to the installation instructions.

ADA, OBC, CSA B651 compliant when installed to the specific requirements of these regulations.