

Features

- A single handle controls both on/off activation and temperature setting
- 9-1/8" (232 mm) high-arc spout
- 8.0 gpm (30.3 lpm) maximum bath faucet flow rate at 45 psi (3.1 bar)
- Includes Shift+® Round 1.75 gpm handshower and 60" hose
- 1.75 gpm (6.6 lpm) maximum handshower flow rate at 80 psi (5.5 bar)
- KOHLER® ceramic disc valves exceed industry longevity standards for a lifetime of durable performance
- Part of the Occasion bathroom faucet and accessory collection

Material

- Premium metal construction for durability and reliability
- KOHLER® finishes resist corrosion and tarnishing

Installation

- Floor-mount

Required Products/Accessories

For freestanding installation

K-97339 Mounting block for select floor-mount bath fillers

Recommended Products/Accessories

K-23723 Faucet cleaner
 K-27060 18" towel bar
 K-27061 24" towel bar
 K-27062 24" double towel bar
 K-27063 Towel ring
 K-27064 Vertical toilet paper holder
 K-27065 Pivoting toilet paper holder
 K-27069 Robe hook
 K-27128 Toilet paper holder with tray

Included Components

K-21335-G Round two-function handshower, 1.75 gpm



Codes/Standards









ASME A112.18.1/CSA B125.1
 DOE - Energy Policy Act 1992
 EPA WaterSense®
 California Energy Commission (CEC)
 IAPMO Certification

KOHLER® Faucet Lifetime Limited Warranty

See website for detailed warranty information.

Available Colors/Finishes

Color tiles intended for reference only.

Color	Code	Description
	CP	Polished Chrome
	SN	Vibrant® Polished Nickel
	AF	Vibrant® French Gold
	BN	Vibrant® Brushed Nickel
	BV	Vibrant® Brushed Bronze
	BL	Matte Black
	2MB	Vibrant® Brushed Moderne Brass
	BMB	Matte Black with Moderne Brass
	TT	Vibrant Titanium

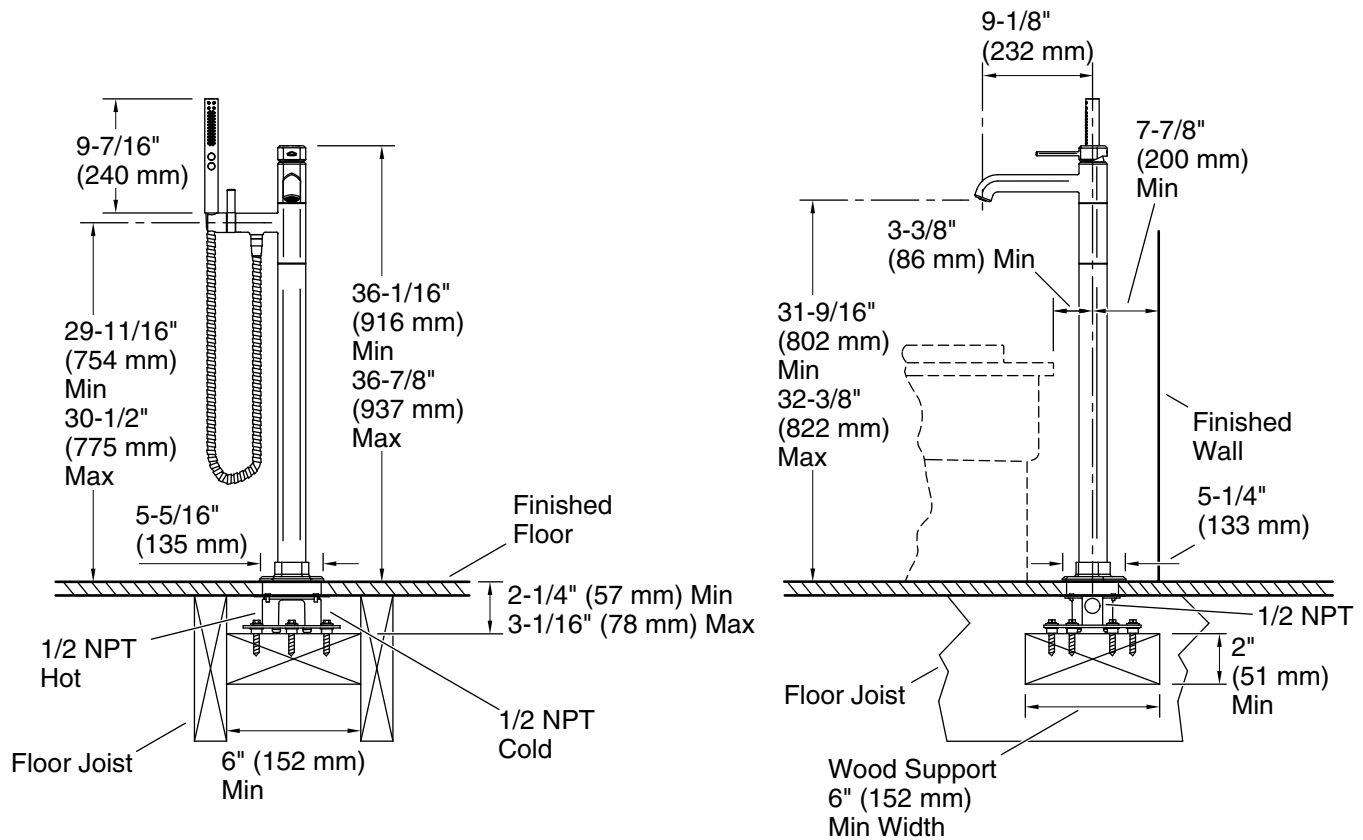

Technical Information

All product dimensions are nominal.

Faucet:

Flow rate: 8 gal/min (30.3 l/min)

Shower Valve:

Pressure: 45 psi (3.1 bar)
 Maximum (Static) Pressure: 125 psi (8.6 bar)
 Minimum (Operating) Pressure: 20 psi (1.4 bar)

Drain included: No

Spout:

Spout reach: 9-1/8" (232 mm)

Handshower:

Rated maximum flow: 1.75 gal/min (6.6 l/min)