

### Features

- Cross handle
- Single handle controls flow to outlets
- 360° handle rotation with three-outlet operation
- 120° handle rotation with two-outlet operation
- Includes faceplate with ADA-compliant metal lever handle
- Part of the Occasion bathroom faucet and accessory collection
- When used with MasterShower 2- or 3-way transfer or diverter valves, handle controls flow to two or three outlets individually or any two outlets at a time

### Material

- Premium material construction with metal handle ensures reliability and durability
- KOHLER® finishes resist corrosion and tarnishing

### Installation

- Patented K-joint installation technology ensures consistent trim appearance, regardless of variability in valve rough-in
- Wall-mount
- Trim only; requires valve to complete installation (sold separately)

### Required Products/Accessories

K-728-K 3/4" two- or three-way transfer valve

or

K-737-K 3/4" Two- or Three-Way Diverter Valve

### Recommended Products/Accessories

K-23723 Faucet cleaner



ADA

CSA B651

OBC

### Codes/Standards

ASME A112.18.1/CSA B125.1

ADA

ICC/ANSI A117.1

CSA B651

OBC









IAPMO Certification

### KOHLER® Faucet Lifetime Limited Warranty

See website for detailed warranty information.

### Available Colors/Finishes

*Color tiles intended for reference only.*

Color	Code	Description
	CP	Polished Chrome
	SN	Vibrant® Polished Nickel
	AF	Vibrant® French Gold
	BN	Vibrant® Brushed Nickel
	BV	Vibrant® Brushed Bronze
	BL	Matte Black
	2MB	Vibrant® Brushed Moderne Brass
	BMB	Matte Black with Moderne Brass
	TT	Vibrant Titanium

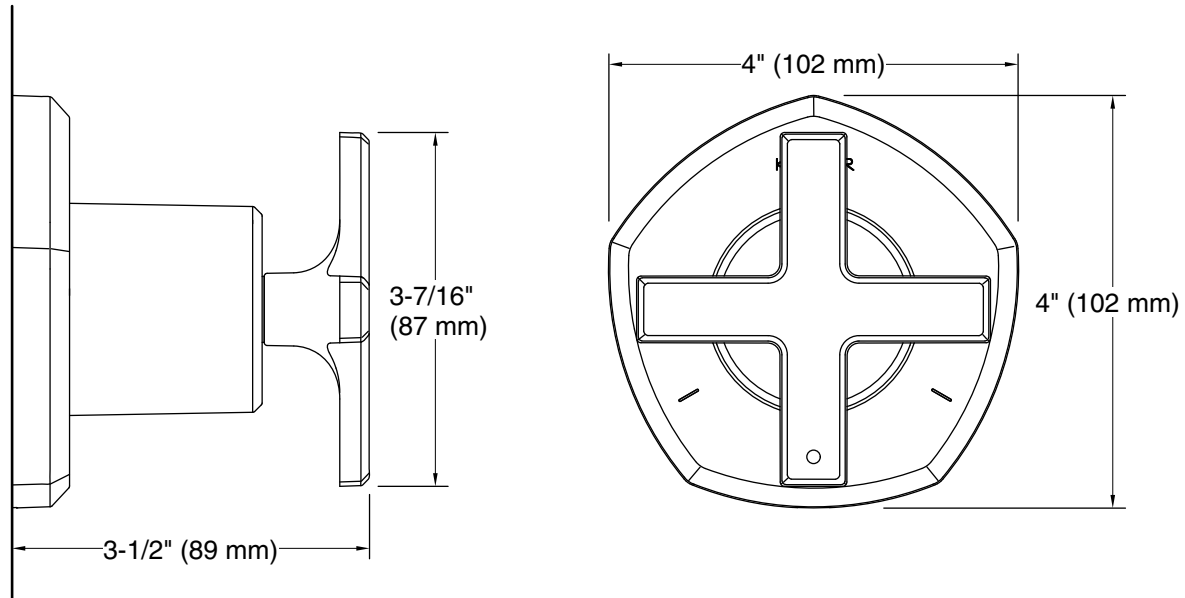

### Technical Information

All product dimensions are nominal.

Drain included: No

### Handshower:

Rated maximum flow: 0 gal/min (0 l/min)

### Notes

ADA, OBC, CSA B651 compliant when installed to the specific requirements of these regulations.