

Features

- A single handle controls both on/off activation and temperature setting
- Includes faceplate with ADA-compliant metal lever handle and push-button diverter
- Pressure-balancing diaphragm technology maintains outlet temperature within +/-3°F during water pressure fluctuations
- Antiscald protection
- Part of the Occasion bathroom faucet and accessory collection

Material

- Premium material construction with metal handle ensures reliability and durability
- KOHLER® finishes resist corrosion and tarnishing

Installation

- Wall-mount
- Trim only; requires valve to complete installation (sold separately)

Required Products/Accessories

K-11748 Series Rite-Temp® Valves

Recommended Products/Accessories

K-23723 Faucet cleaner



Codes/Standards

ASME A112.18.1/CSA B125.1

ADA

ICC/ANSI A117.1

CSA B651

OBC









IAPMO Certification

KOHLER® Faucet Lifetime Limited Warranty

See website for detailed warranty information.

Available Colors/Finishes

Color tiles intended for reference only.

Color	Code	Description
	CP	Polished Chrome
	SN	Vibrant® Polished Nickel
	AF	Vibrant® French Gold
	BN	Vibrant® Brushed Nickel
	BV	Vibrant® Brushed Bronze
	BL	Matte Black
	2MB	Vibrant® Brushed Moderne Brass
	BMB	Matte Black with Moderne Brass
	TT	Vibrant Titanium

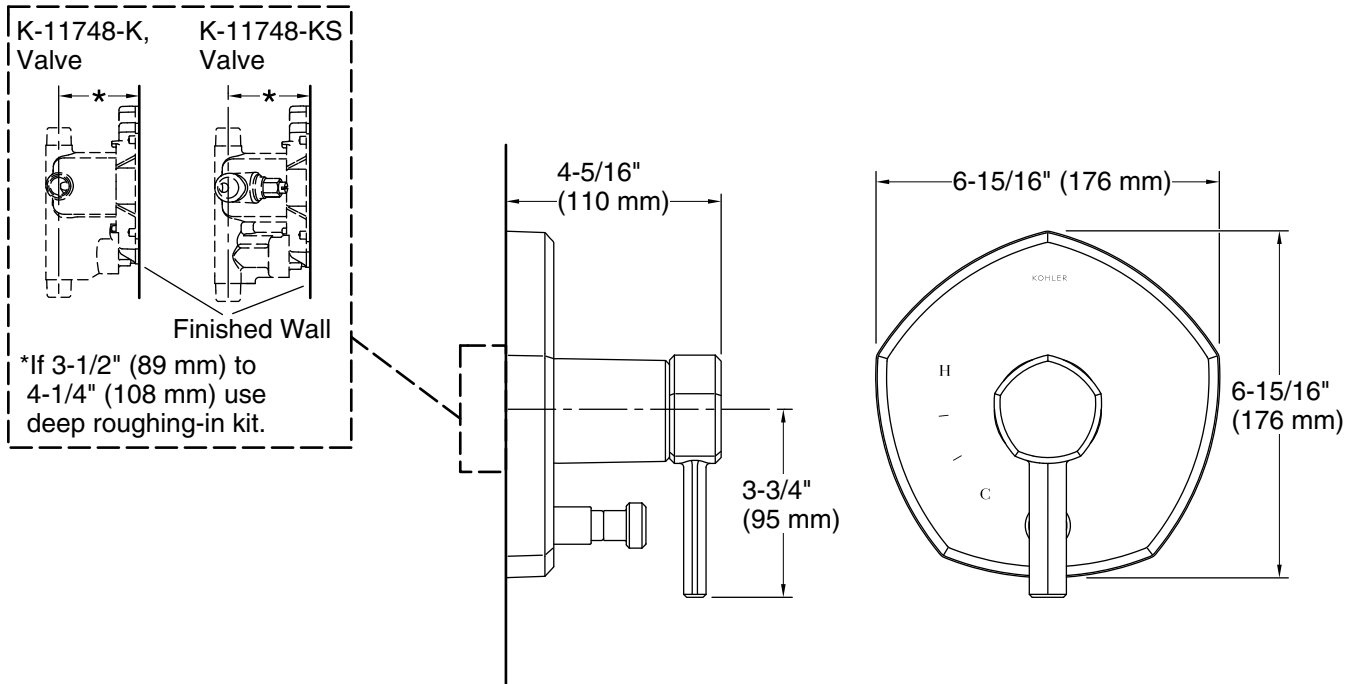

Technical Information

All product dimensions are nominal.

Drain included: No

Spout:

Handshower:

Rated maximum flow: 0 gal/min (0 l/min)

Notes

ADA, OBC, CSA B651 compliant when installed to the specific requirements of these regulations.