

### Features

- Includes faceplate with handle
- Single handle controls temperature setting
- Complements Artifacts faucets and accessories

### Material

- Premium material construction with metal handle ensures reliability and durability
- KOHLER® finishes resist corrosion and tarnishing

### Installation

- Trim only; requires valve to complete installation (sold separately)
- Patented K-joint installation technology ensures consistent trim appearance, regardless of variability in valve rough-in

### Required Products/Accessories

K-2972-KS 1/2" thermostatic mixing valve

or

K-2975-KS 3/4" Thermostatic Mixing Valve

### Recommended Products/Accessories

K-23723 Faucet cleaner



ADA CSA B651 OBC

### Codes/Standards

ASME A112.18.1/CSA B125.1

ADA

ICC/ANSI A117.1

CSA B651

OBC









IAPMO Certification

### KOHLER® Faucet Lifetime Limited Warranty

See website for detailed warranty information.

### Available Colors/Finishes

*Color tiles intended for reference only.*

Color	Code	Description
	CP	Polished Chrome
	SN	Vibrant® Polished Nickel
	AF	Vibrant® French Gold
	BN	Vibrant® Brushed Nickel
	BV	Vibrant® Brushed Bronze
	BL	Matte Black
	2MB	Vibrant® Brushed Moderne Brass
	TT	Vibrant Titanium

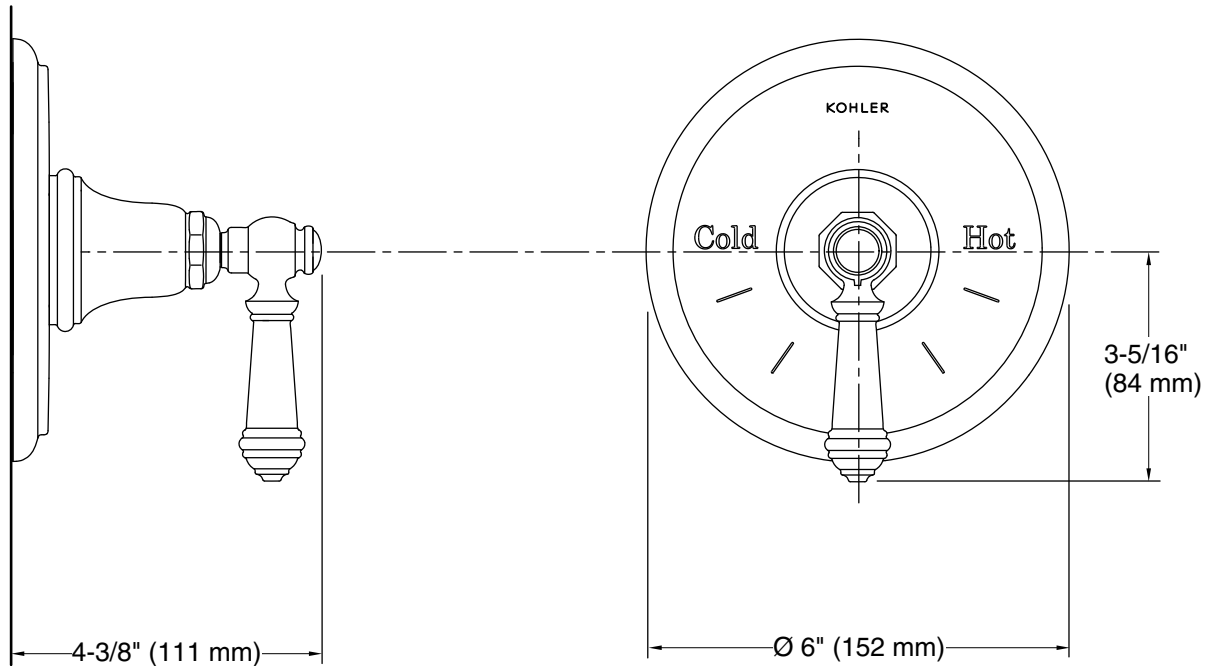

**Technical Information**

All product dimensions are nominal.

**Handshower:**

Rated maximum flow: 0 gal/min (0 l/min)

**Notes**

Install this product according to the installation instructions.

ADA, OBC, CSA B651 compliant when installed to the specific requirements of these regulations.