

Features

- Includes faceplate with handle
- Single handle provides on/off activation and volume control
- Cross handle
- Complements Artifacts faucets and accessories

Material

- Premium material construction with metal cross handle ensures reliability and durability
- KOHLER® finishes resist corrosion and tarnishing

Installation

- Trim only; requires valve to complete installation (sold separately)
- Patented K-joint installation technology ensures consistent trim appearance, regardless of variability in valve rough-in

Required Products/Accessories

K-2974-K 1/2" volume control valve

or

K-2977-K 3/4" Volume Control Valve

Recommended Products/Accessories

K-23723 Faucet cleaner



ADA

Codes/Standards

ASME A112.18.1/CSA B125.1

ADA

ICC/ANSI A117.1









IAPMO Certification

KOHLER® Faucet Lifetime Limited Warranty

See website for detailed warranty information.

Available Colors/Finishes

Color tiles intended for reference only.

Color	Code	Description
	CP	Polished Chrome
	SN	Vibrant® Polished Nickel
	AF	Vibrant® French Gold
	BN	Vibrant® Brushed Nickel
	BV	Vibrant® Brushed Bronze
	BL	Matte Black
	2MB	Vibrant® Brushed Moderne Brass
	TT	Vibrant Titanium

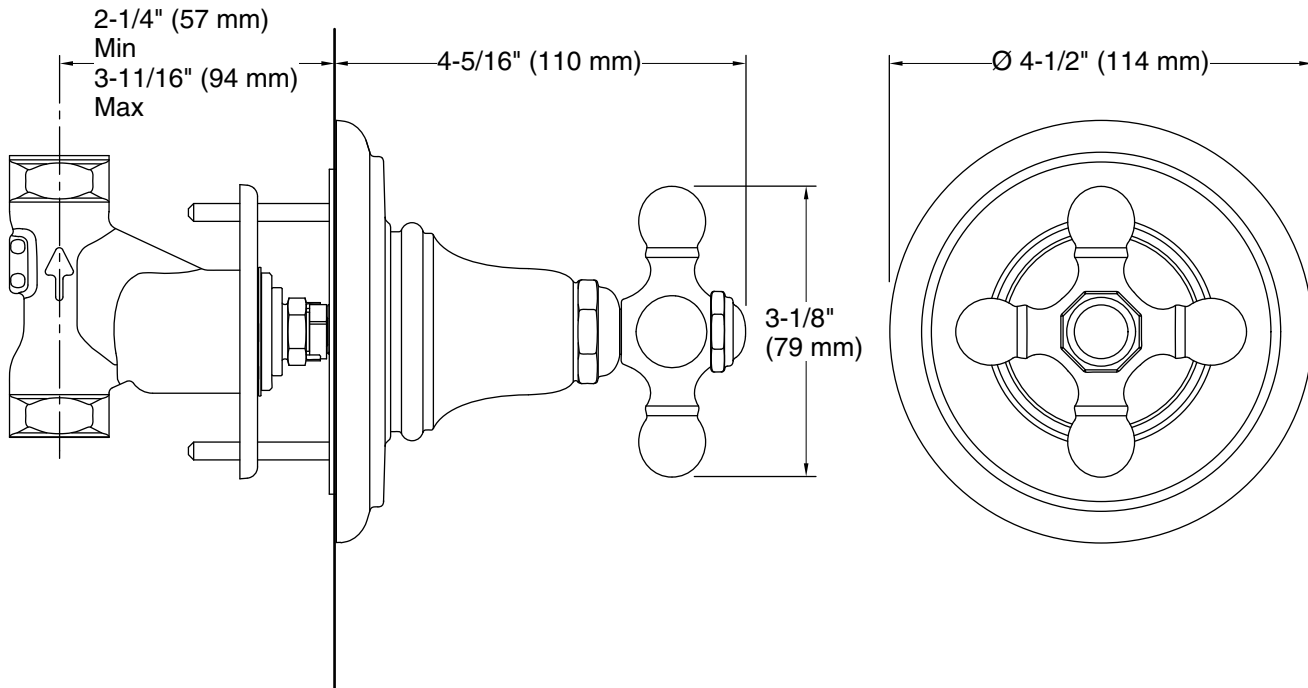

Technical Information

All product dimensions are nominal.

Handshower:

Rated maximum flow: 0 gal/min (0 l/min)

Notes

Install this product according to the installation instructions.

ADA compliant when installed to the specific requirements of these regulations.