

Features

- Single Industrial handle controls flow to outlets
- Coordinates with Components faucets, accessories, and showering components to complete your bathroom

Material

- Premium material construction with metal handle ensures reliability and durability
- KOHLER® finishes resist corrosion and tarnishing

Installation

- Wall-mount
- Patented K-joint installation technology ensures consistent trim appearance, regardless of variability in valve rough-in

Required Products/Accessories

K-728-K 3/4" Two- or Three-Way Transfer Valve

or

K-737-K 3/4" Two- or Three-Way Diverter Valve

Recommended Products/Accessories

K-23723 Faucet cleaner



Codes/Standards

ASME A112.18.1/CSA B125.1









IAPMO Certification

KOHLER® Faucet Lifetime Limited Warranty

See website for detailed warranty information.

Available Colors/Finishes

Color tiles intended for reference only.

Color	Code	Description
	CP	Polished Chrome
	SN	Vibrant® Polished Nickel
	AF	Vibrant® French Gold
	BN	Vibrant® Brushed Nickel
	BV	Vibrant® Brushed Bronze
	BL	Matte Black
	2MB	Vibrant® Brushed Moderne Brass
	TT	Vibrant Titanium

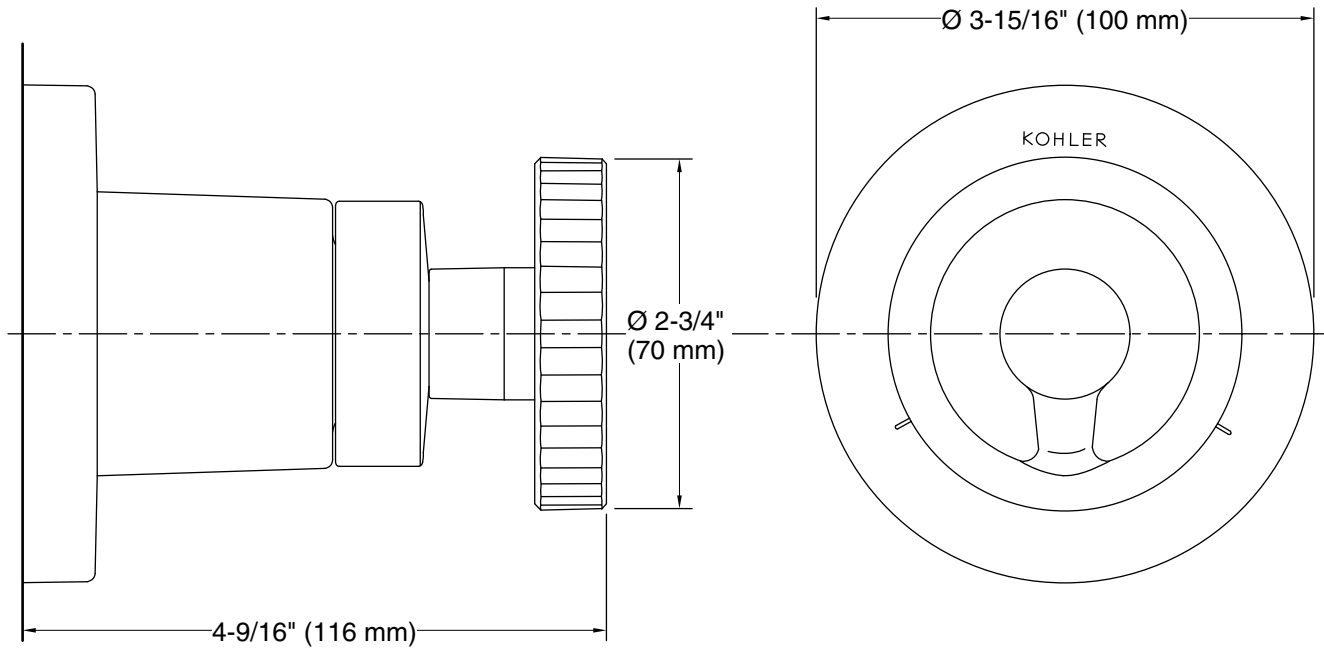

Technical Information

All product dimensions are nominal.

Drain included: No

Notes

Install this product according to the installation instructions.