

# KOHLER® Faucets

Deck-mount bath faucet handle trim with Lever design  
**Artifacts®**  
**K-T98071-4**

## Features

- Lever handle style option
- Metal construction

## Installation

- Bath- or deck-mount

## Recommended Products/Accessories

- K-23723 Faucet cleaner
- K-72567 18" Towel Bar
- K-72568 24" Towel Bar
- K-72570 24" Double Towel Bar
- K-72571 Towel Ring
- K-72572 Robe Hook
- K-72573 Pivoting toilet paper holder
- K-72576 Toilet paper carriage



**ADA** **CSA B651** **OBC**

## Codes/Standards









ASME A112.18.1/CSA B125.1  
 ADA  
 ICC/ANSI A117.1  
 CSA B651  
 OBC  
 IAPMO Certification

## KOHLER® Faucet Lifetime Limited Warranty

See website for detailed warranty information.

## Available Colors/Finishes

*Color tiles intended for reference only.*

Color	Code	Description
	CP	Polished Chrome
	SN	Vibrant® Polished Nickel
	AF	Vibrant® French Gold
	BN	Vibrant® Brushed Nickel
	BV	Vibrant® Brushed Bronze
	2BZ	Oil-Rubbed Bronze
	BL	Matte Black
	2MB	Vibrant® Brushed Moderne Brass
	TT	Vibrant Titanium

1-800-4KOHLER (1-800-456-4537)

Kohler Co. reserves the right to make revisions without notice to product specifications.

For the most current Specification Sheet, go to [www.kohler.com](http://www.kohler.com) USA or [www.kohler.ca](http://www.kohler.ca) Canada

12-11-2024 22:23 - US/CA

THE BOLD LOOK  
 OF **KOHLER®**

**KOHLER** Faucets Deck-mount bath faucet handle trim with Lever design  
**Artifacts®**  
**K-T98071-4**

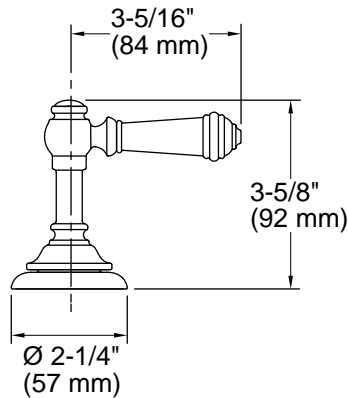

**Technical Information**

All product dimensions are nominal.

Drain included: No

**Spout:**

**Handshower:**

Rated maximum flow: 0 gal/min (0 l/min)

**Notes**

Install this product according to the installation instructions.

**IMPORTANT!** Artifacts deck-mount handles are only compatible with the valve included with the Artifacts deck-mount faucets. Do not install to a K-300 bath valve.

ADA, OBC, CSA B651 compliant when installed to the specific requirements of these regulations.