

Features

- Includes faceplate with metal cross handle
- A single handle controls both on/off activation and temperature setting
- Metal cross handle
- Coordinates with Artifacts faucets and accessories

Material

- Premium material construction with metal handle ensures reliability and durability

Installation

- Trim only; requires valve to complete installation (sold separately)

Required Products/Accessories

K-8304 Series Rite-Temp® Valve & Cartridge Kits

or

K-8300 Series Rite-Temp® Valve Body Rough-ins

or

K-8300 Series Rite-Temp® Valve Body Rough-ins

K-8305 Series Rite-Temp® Cartridges

or

K-8300 Series Rite-Temp® Valve Body Rough-ins (Qty 2)

K-8305 Series Rite-Temp® Cartridges

or

K-8305 Series Rite-Temp® Cartridges

Recommended Products/Accessories

K-23723 Faucet cleaner



ADA

Codes/Standards

ASME A112.18.1/CSA B125.1

ADA

ICC/ANSI A117.1









IAPMO Certification

KOHLER® Faucet Lifetime Limited Warranty

See website for detailed warranty information.

Available Colors/Finishes

Color tiles intended for reference only.

Color	Code	Description
	CP	Polished Chrome
	SN	Vibrant® Polished Nickel
	AF	Vibrant® French Gold
	BN	Vibrant® Brushed Nickel
	BV	Vibrant® Brushed Bronze
	BL	Matte Black
	2MB	Vibrant® Brushed Moderne Brass
	TT	Vibrant Titanium

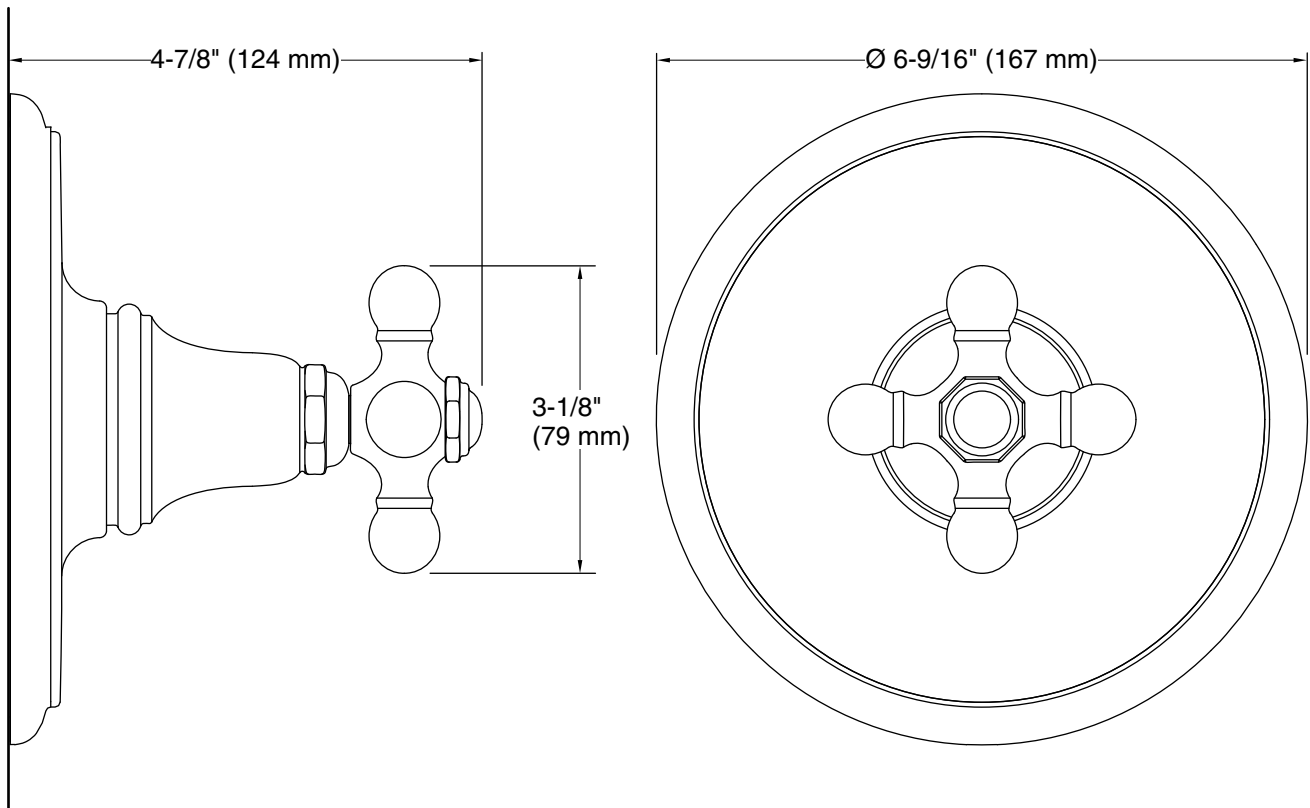

Technical Information

All product dimensions are nominal.

Handshower:

Rated maximum flow: 0 gal/min (0 l/min)

Notes

Install this product according to the installation instructions.

ADA compliant when installed to the specific requirements of these regulations.