

### Features

- A selection of products within this collection is in stock and ready to ship. Please visit [kallista.com/resources/#ReadyToShip](http://kallista.com/resources/#ReadyToShip) for the complete list of Ready-to-Ship products and finishes
- High-quality solid-brass construction for durability and reliability
- Required shower arm sold separately
- Maximum flow rate of 2.5 gpm (9.5 lpm)
- Single-function spray
- Includes escutcheon
- Diameter is 11-1/8" (283 mm)

### Required Products/Accessories

P21520-00 Rain Showerhead Arm

or

P21521-00 Rain Showerhead Arm

or

P21522-00 12" ceiling-mount rain showerhead arm

or

P21523-00 Wall-Mount Rain Showerhead Arm

### Recommended Products/Accessories

P24761-00 Handshower with Hose



### Codes/Standards

ASME A112.18.1/CSA B125.1

DOE - Energy Policy Act 1992

NOM Standards











NOM 008-CONAGUA

### KALLISTA® Five-Year Limited Warranty

See website for detailed warranty information.

### Available Colors/Finishes

*Color tiles intended for reference only.*

Color	Code	Description
	CP	Polished Chrome
	BL	Matte Black
	ULB	Unlacquered Brass
	AF	French Gold
	BAF	Brushed French Gold
	BGP	Brushed Graphite
	BN	Brushed Nickel
	PGP	Polished Graphite
	SN	Polished Nickel
	2MB	Brushed Moderne Brass

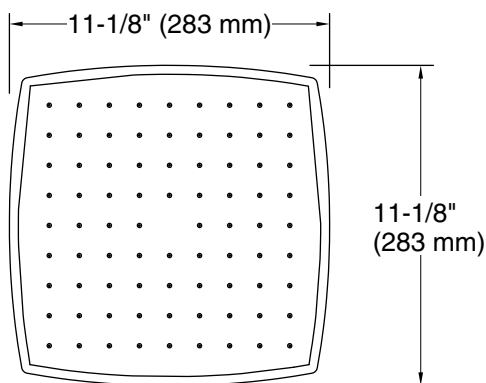
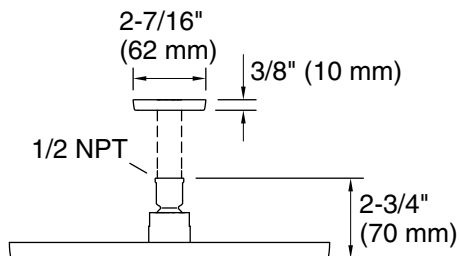

## Technical Information

All product dimensions are nominal.

Shower/Rainhead rated max flow: 2.5 gal/min (9.5 l/min)

## Notes

For use with automatic compensating valves rated at 2.5 gal/min (9.5 l/min) or less.

Install this product according to the installation instructions.