

# KALLISTA®

## Laura Kirar Air-Induction Transitional Rain Showerhead P21676-00

### Features

- High-quality solid-brass construction for durability and reliability
- Required shower arm sold separately
- 1.75 gpm (6.6 lpm) maximum flow rate
- Single-function spray
- Includes escutcheon
- Diameter is 10-1/4" (260 mm)

### Required Products/Accessories

P21520-00 Rain Showerhead Arm

or

P21521-00 Rain Showerhead Arm

or

P21522-00 12" ceiling-mount rain showerhead arm

or

P21523-00 Wall-Mount Rain Showerhead Arm

### Recommended Products/Accessories

P24933-CPH Towel Bar, 18"

P24914-CPH Wall-Mount Bath Spout

P25656-00 Transitional Handshower with Hose

P24922-CPH Thermostatic Shower Trim, Lever Handle



### Codes/Standards

ASME A112.18.1/CSA B125.1

DOE - Energy Policy Act 1992

EPA WaterSense®

California Energy Commission (CEC)

NOM Standards









NOM 008-CONAGUA

### KALLISTA® Five-Year Limited Warranty

See website for detailed warranty  
information.

### Available Colors/Finishes

*Color tiles intended for reference only.*

Color	Code	Description
	CP	Polished Chrome
	ULB	Unlacquered Brass
	BAF	Brushed French Gold
	BGP	Brushed Graphite
	BN	Brushed Nickel
	PGP	Polished Graphite
	SN	Polished Nickel
	2MB	Brushed Moderne Brass
	BV	Brushed Bronze

1-888-4-KALLISTA (1-888-452-5547)

Kallista reserves the right to make revisions without notice to product specifications.

For the most current Specification Sheet, go to [www.kallista.com](http://www.kallista.com).

9-12-2025 14:00 - US/CA

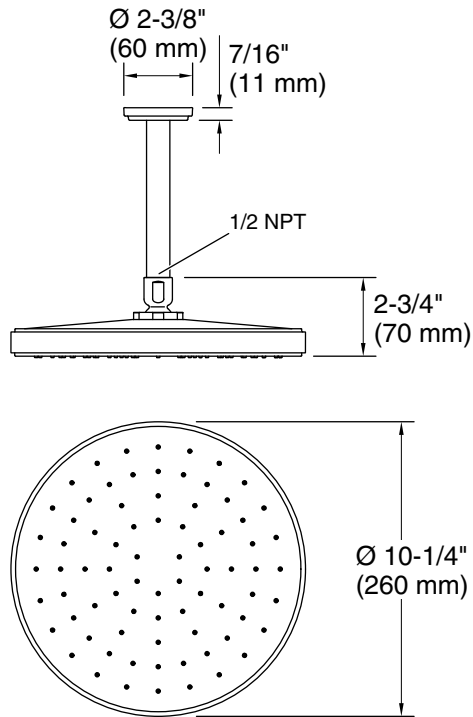

## Technical Information

All product dimensions are nominal.

Shower/Rainhead rated max flow: 1.75 gal/min (6.6 l/min)

## Notes

For use with automatic compensating valves rated at 1.75 gal/min (6.6 l/min) or less.