

KALLISTA®

KALLISTA Contemporary filter faucet P23148-LV

Features

- A selection of products within this collection is in stock and ready to ship. Please visit kallista.com/readytoship for the complete list of Ready-to-Ship products and finishes
- High-quality solid metal construction for durability and reliability
- Spout reach is 4-7/8" (124 mm)
- 1.5 gpm (5.7 lpm) maximum flow rate
- Single-hole installation with 360-degree swing spout
- Requires a water filtration system
- Compatible with KOHLER® Aquifer® Water Filtration System (K-77685-NA or K-77686-NA)

Recommended Products/Accessories

P23174-2MB Semi-Professional Faucet
P23175-SN
P23181-2MB Wall-Mount Pot Filler
P23180-00 Soap/Lotion Dispenser



ADA

CSA B651

Codes/Standards











ASME A112.18.1/CSA B125.1
NSF/ANSI/CAN 61
NSF/ANSI/CAN 372
DOE - Energy Policy Act 1992
California Energy Commission (CEC)
ADA
ICC/ANSI A117.1
CSA B651

KALLISTA® Five-Year Limited Warranty

See website for detailed warranty information.

Available Colors/Finishes

Color tiles intended for reference only.

Color	Code	Description
	CP	Polished Chrome
	BL	Matte Black
	ULB	Unlacquered Brass
	BAF	Brushed French Gold
	BGP	Brushed Graphite
	BN	Brushed Nickel
	PGP	Polished Graphite
	SN	Polished Nickel
	VS	Stainless
	2MB	Brushed Moderne Brass

1-888-4-KALLISTA (1-888-452-5547)

Kallista reserves the right to make revisions without notice to product specifications.

For the most current Specification Sheet, go to www.kallista.com.

2-20-2025 21:40 - US/CA

KALLISTA

KALLISTA
Contemporary filter faucet
P23148-LV

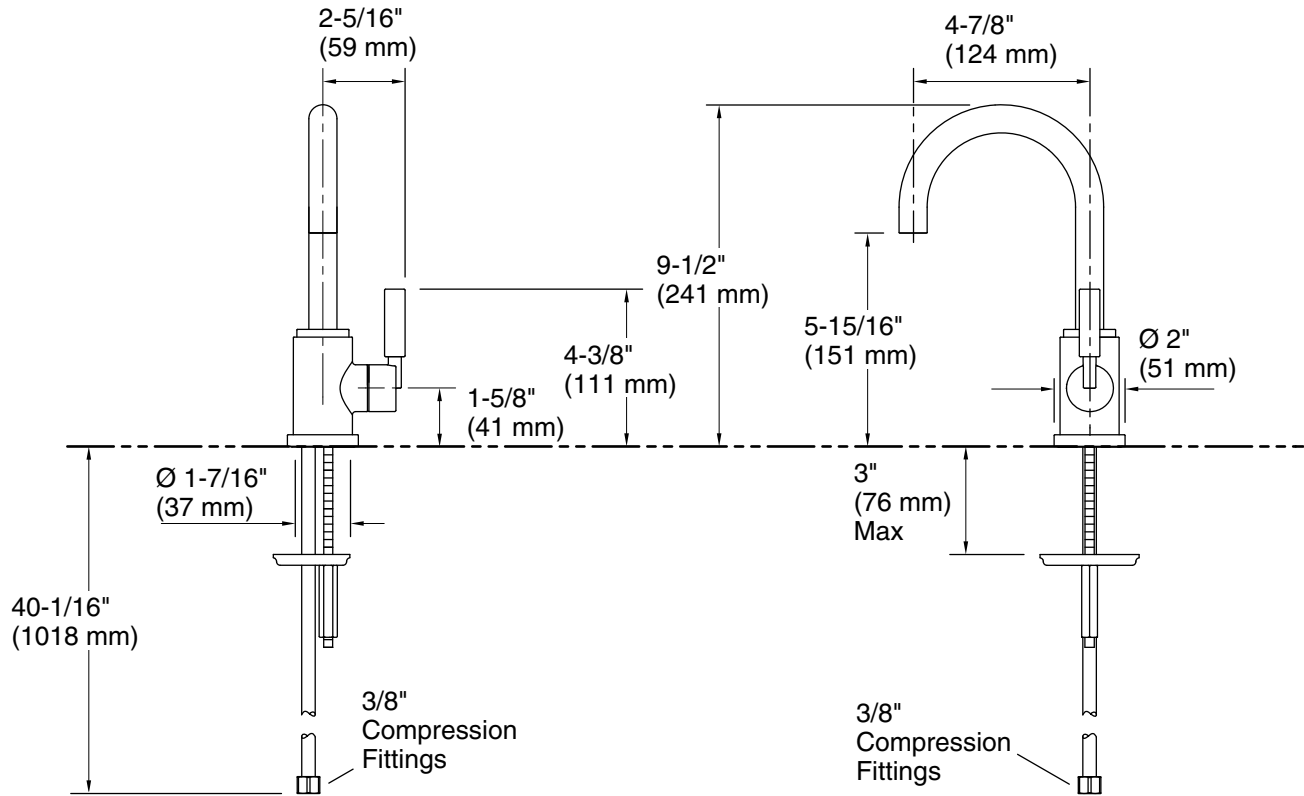

Technical Information

All product dimensions are nominal.

Faucet flow rate: 1.5 gal/min (5.7 l/min)

Drain included: No

Spout:

Spout reach: 4-7/8" (124 mm)

Pressure/fixture Supply Requirements

Min flow rate: 1.2 gpm (4.5 lpm)

Notes

Install this product according to the installation instructions.

ADA compliant for faucet handles only
ADA, CSA B651 compliant when installed to the specific requirements of these regulations.

1-888-4-KALLISTA (1-888-452-5547)

Kallista reserves the right to make revisions without notice to product specifications.

For the most current Specification Sheet, go to www.kallista.com.

2-20-2025 21:40 - US/CA