

KALLISTA®

One™ by KALLISTA Wall-mount bath faucet handles, cross P24508-CR

Features

- High-quality solid-brass construction for durability and reliability
- Wall-mount bath spout sold separately
- Required rough-in sold separately
- Unlacquered Brass (ULB) available in North America and the United Kingdom only

Required Products/Accessories

P20996-00

Adapters, Rough-in and Extension Kits

P20996-00 Range: 2-1/4" (57 mm) -
3" (76 mm)

Recommended Products/Accessories

P24421-CR Thermostatic trim, cross handle
P24416-CR Pressure balance trim with diverter, cross handle
P34410-00 Towel Ring
P21512-G Air-Induction ECO Small Contemporary Rain Showerhead



ADA

CSA B651

OBC

Codes/Standards

ASME A112.18.1/CSA B125.1

ADA

ICC/ANSI A117.1

CSA B651











OBC

KALLISTA® Five-Year Limited Warranty

See website for detailed warranty information.

Available Colors/Finishes

Color tiles intended for reference only.

Color	Code	Description
	CP	Polished Chrome
	GN	Gunmetal
	BL	Matte Black
	ULB	Unlacquered Brass
	BAF	Brushed French Gold
	BGP	Brushed Graphite
	BN	Brushed Nickel
	PGP	Polished Graphite
	SN	Polished Nickel
	2MB	Brushed Moderne Brass

1-888-4-KALLISTA (1-888-452-5547)

Kallista reserves the right to make revisions without notice to product specifications.

For the most current Specification Sheet, go to www.kallista.com.

3-15-2025 20:03 - US/CA

KALLISTA.

One™ by KALLISTA
Wall-mount bath faucet handles, cross
P24508-CR

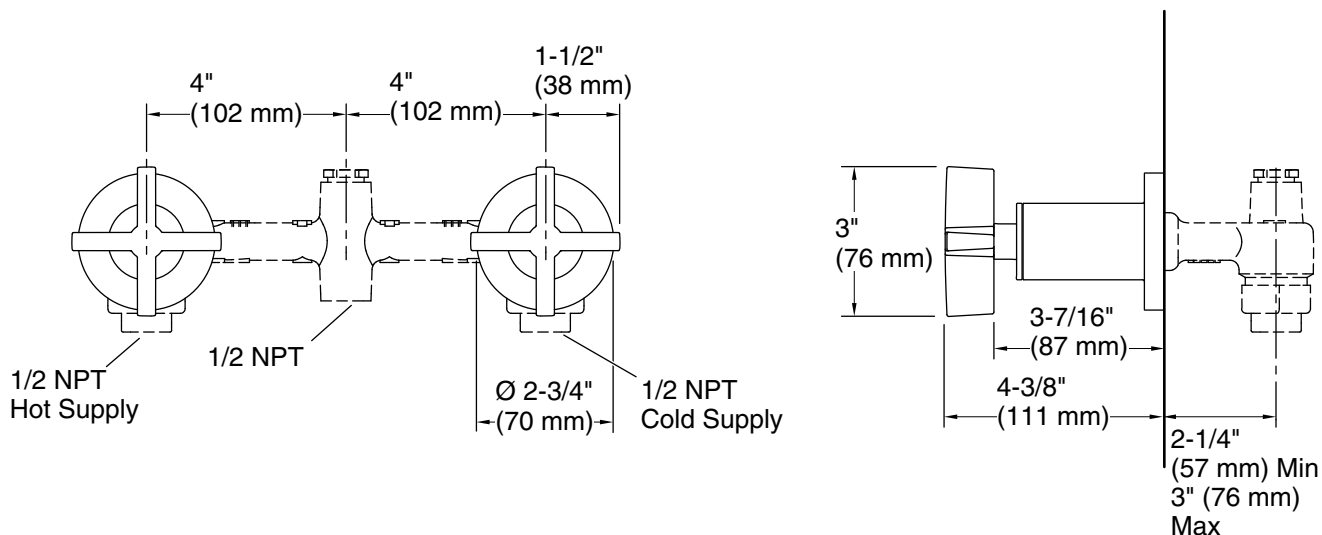

Technical Information

All product dimensions are nominal.

Notes

Install this product according to the installation instructions.

ADA, OBC, CSA B651 compliant when installed to the specific requirements of these regulations.