

KALLISTA®

Per Se® by KALLISTA Sink Faucet, Tall Spout, Lever Handles P24736-LV

Features

- A selection of products within this collection is in stock and ready to ship. Please visit kallista.com/readytoship for the complete list of Ready-to-Ship products and finishes
- High-quality solid metal construction for durability and reliability
- Widespread sink faucet for 8" – 16" (203 – 406 mm) centers
- 1.2 gpm (4.5 lpm) maximum flow rate
- Spout reach is 5-11/16" (144 mm)
- Includes soft-touch drain
- Laminar flow
- Lift rod option available for projects

Recommended Products/Accessories

- P74234-WO Under-mount Sink, Soft Rectangle with Overflow, Glazed
- P24702-LV Wall-Mount Sink Faucet, Lever Handles
- P34700-00 Towel Bar, 24"
- P34706-00 Hook



ADA **CSA B651** **OBC**

Codes/Standards







- ASME A112.18.1/CSA B125.1
- NSF/ANSI/CAN 61
- NSF/ANSI/CAN 372
- DOE - Energy Policy Act 1992
- EPA WaterSense®
- California Energy Commission (CEC)
- ADA
- ICC/ANSI A117.1
- CSA B651
- OBC

KALLISTA® Five-Year Limited Warranty

See website for detailed warranty information.

Available Colors/Finishes

Color tiles intended for reference only.

| Color | Code | Description |
|---|------|---------------------|
|  | CP | Polished Chrome |
|  | AF | French Gold |
|  | BAF | Brushed French Gold |
|  | BN | Brushed Nickel |
|  | SN | Polished Nickel |
|  | YG | Matte Gold |

1-888-4-KALLISTA (1-888-452-5547)

Kallista reserves the right to make revisions without notice to product specifications.

For the most current Specification Sheet, go to www.kallista.com.

3-25-2025 00:49 - US/CA

KALLISTA

Per Se[®] by KALLISTA
Sink Faucet, Tall Spout, Lever Handles
P24736-LV

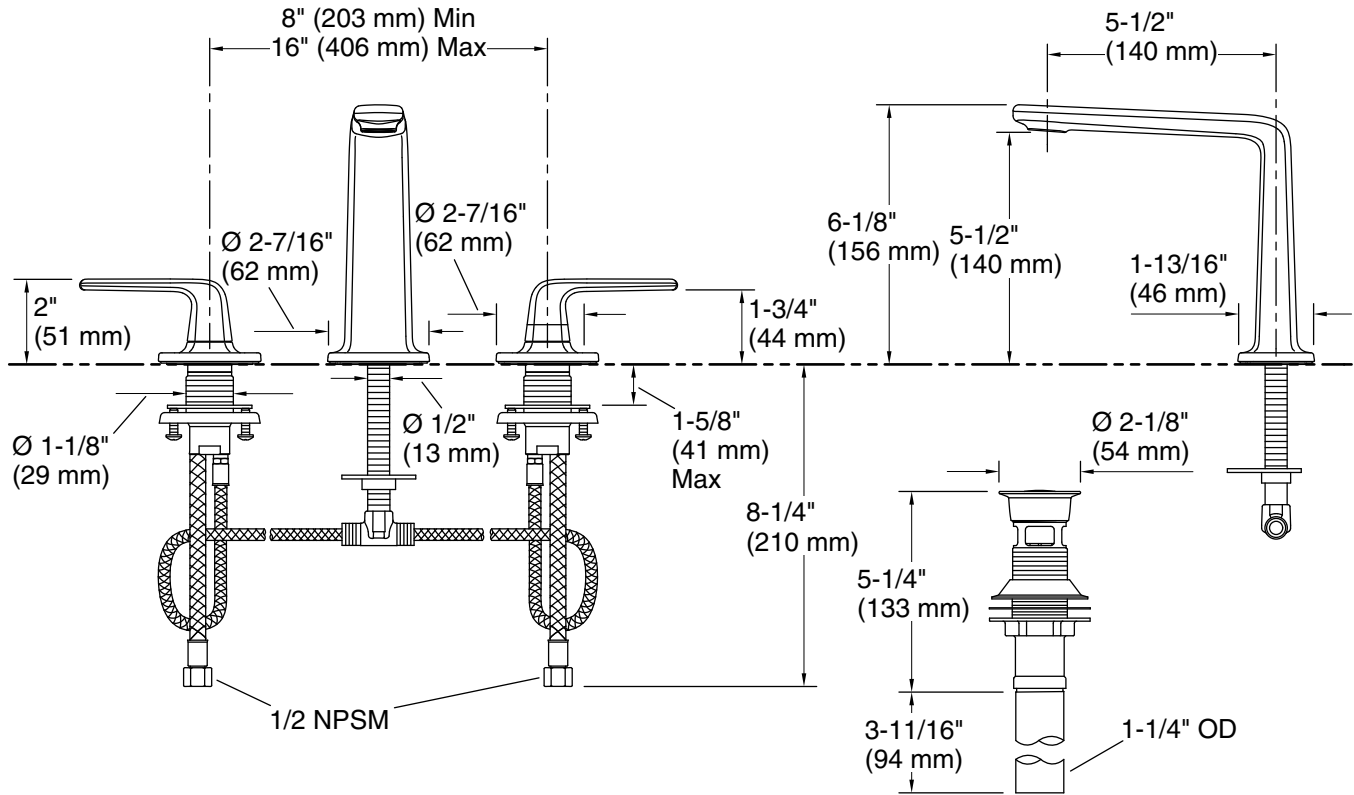

Technical Information

All product dimensions are nominal.

Faucet flow rate: 1.2 gal/min (4.5 l/min)

Drain included: Yes

Drain with overflow: Yes

Spout:

Spout reach: 5-1/2" (140 mm)

Pressure/fixture Supply Requirements

Min flow rate: 1.2 gpm (4.5 lpm)

Notes

ADA, OBC, CSA B651 compliant when installed to the specific requirements of these regulations.

1-888-4-KALLISTA (1-888-452-5547)

Kallista reserves the right to make revisions without notice to product specifications.

For the most current Specification Sheet, go to www.kallista.com.

3-25-2025 00:49 - US/CA